

Barostim ™ *neo*

SYSTEM REFERENCE GUIDE

1.	SYSTEM DESCRIPTION	1-1
	Implantable Pulse Generator (IPG).....	1-1
	Carotid Sinus Leads (CSL).....	1-2
	Implant Adapter.....	1-2
	Implant Tool.....	1-2
	CVRx Programmer System Model 9010.....	1-3
	Programmer Software/Computer.....	1-3
	Programmer Interface.....	1-3
	Optional Accessories for Use with the System.....	1-4
	CVRx Magnet.....	1-4
	CVRx Accessory Kit.....	1-4
	CSL Repair Kit Model 5010.....	1-4
2.	SYMBOLS AND DEFINITIONS	2-1
3.	INDICATIONS	3-1
4.	CONTRAINDICATIONS	4-1
5.	WARNINGS AND PRECAUTIONS	5-1
	General.....	5-1
	Warnings.....	5-1
	Precautions.....	5-1
	Implantable Pulse Generator.....	5-2
	Warnings.....	5-2
	Precautions.....	5-2
	Carotid Sinus Lead.....	5-3
	Warnings.....	5-3
	Precautions.....	5-3
	CVRx Programmer System.....	5-4
	Warning.....	5-4
	Precautions.....	5-4
	CVRx Magnet.....	5-4
	Precaution.....	5-4
	Accessory Kit, Implant Adapter, Implant Tool.....	5-4
	Warnings.....	5-4
	Precautions.....	5-4
6.	ADVERSE EVENTS	6-1
7.	PHYSICIAN TRAINING AND EXPERIENCE	7-1
8.	SYSTEM PREPARATION	8-1
	How Supplied.....	8-1
	Implantable Pulse Generator.....	8-1
	Carotid Sinus Lead.....	8-1
	Implant Accessories.....	8-1
	Programmer System.....	8-1
	Inspection Prior to Use.....	8-1
	Implantable Pulse Generator.....	8-1
	Carotid Sinus Lead, Implant Adapter, and Implant Tool.....	8-1
	Materials Recommended for Implantation and/or Explantation.....	8-2
	Cleaning the Programmer System.....	8-2
	Programmer System Set Up.....	8-2
9.	PROGRAMMER SYSTEM OPERATION	9-1
	Navigating.....	9-1
	User Login.....	9-1
	Language and Region Selection.....	9-1
	Starting the Application.....	9-2
	Connection Dialog.....	9-2

	
	Main Screen	9-2
	Patient Identification	9-2
	IPG Status	9-2
	Current Therapy Status	9-3
	Quickly–Stopping All Applied Therapies	9-3
	Battery Life	9-3
	Lead Impedance	9-3
	Confirming a Good Telemetry Link	9-3
	Therapy Settings	9-4
	Changing a Parameter Setting	9-4
	Edit and Test Screen	9-5
	Adjusting the Schedule	9-6
	IPG Diagnostics	9-6
	Estimating Longevity of Implantable Pulse Generator	9-7
	Device Interaction Testing	9-7
10.	IMPLANTATION PROCEDURE	10-1
	Before Implantation	10-1
	System Implantation	10-1
	Skin Preparation	10-1
	Antibiotic Coverage	10-2
	Anesthesia	10-2
	Opening the Sterile Package	10-3
	Implantation and Mapping Procedure	10-3
	Final Lead Position Verification	10-9
	Strain Relief, Tunneling and Pocket Creation	10-10
	Lead Connection and Wound Closure	10-11
	Pre Discharge Device Testing	10-14
	Additional Lead Implant (if required)	10-14
11.	IPG REPLACEMENT PROCEDURE	11-1
	Recommendations	11-1
	Antibiotic Coverage	11-1
	Explantation of Depleted IPG	11-1
	Implantation of Replacement IPG	11-1
12.	EXPLANTATION PROCEDURE	12-1
	Recommendations	12-1
	Antibiotic Coverage – Not Infected	12-1
	Antibiotic Coverage – Infected	12-1
	IPG Explantation	12-1
	CSL Explantation	12-2
13.	INSTRUCTIONS FOR PATIENTS	13-1
14.	EMERGENCY PERSONNEL INFORMATION	14-1
	Radiopaque Identifier	14-1
	ECG Artifact	14-1
	Temporarily Inhibiting the IPG Output	14-1
15.	TROUBLESHOOTING	15-1
	CVRx Contact Information	15-1
	Programmer System and Warning messages	15-1
16.	WARRANTY / DISCLAIMER OF WARRANTY	16-1
17.	REGULATORY NOTICES	17-1
18.	SPECIFICATIONS OF NONIMPLANTABLE COMPONENTS	18-1
	Programmer System	18-1
	Programmer System Components	18-1
	Computer	18-1

	Miscellaneous Information	18-2
19.	SPECIFICATIONS OF IMPLANTABLE COMPONENTS	19-1
	Pulse Generator.....	19-1
	Pulse Generator Parameters.....	19-1
	Lead (Models 1036 and 1037).....	19-2
20.	ELECTROMAGNETIC COMPATIBILITY DECLARATIONS	20-1
	Programmer System EMC Precautions	20-1
	Programmer System RF Specifications	20-1
21.	R&TTE DECLARATION OF CONFORMITY (DOC)	21-1

TABLE OF FIGURES

Figure 1: Neo (excluding Implant Adapter and Implant Tool).....	1-1
Figure 2: Implantable Pulse Generator	1-1
Figure 3: Carotid Sinus Lead.....	1-2
Figure 4: Implant Adapters.....	1-2
Figure 5: Implant Tool	1-2
Figure 6: Programmer System Model 9010	1-3
Figure 7: CVRx Magnet.....	1-4
Figure 8: CVRx Accessory Kit.....	1-4
Figure 9: Language and Region Selector Screen.....	9-1
Figure 10: Link Quality Indicator (Excellent, Poor, No Link)	9-4
Figure 11: Example Schedule.....	9-6
Figure 12: System Mapping Configuration for Implant Adapter Model 5030	10-5
Figure 13: System Mapping Configuration for Implant Adapter Model 5033	10-5
Figure 14: Implant Adapter Configuration and IPG Connection for Implant Adapter Model 5033	10-6
Figure 15: Buckle lead engaged in Buckle Implant Tool	10-6
Figure 16: Systematic Mapping Strategy for Different Locations on the Exposed Carotid Sinus.	10-7
Figure 17: Recommended Suture Locations	10-8
Figure 18: Depth of Suture	10-9
Figure 19: Strain Relief Example	10-10
Figure 20: Terminal Insertion into IPG Header (Correct Insertion)	10-12
Figure 21: Terminal Insertion into IPG Header (Incorrect Insertion).....	10-12
Figure 22: Correct Placement of Excess Lead Body	10-13
Figure 23: Incorrect Placement of Excess Lead Body.....	10-13
Figure 24: Radiopaque Identifier.....	14-1
Figure 25: Implanted Location of IPG	14-1

LIST OF TABLES

Table 1: Parameter Settings.....	9-4
Table 2: Effect of Parameter Changes on Device Longevity (listed in months)	9-7
Table 3: Electromagnetic Emissions	20-2
Table 4: Electromagnetic Immunity.....	20-2
Table 5: Separation Distance.....	20-4

1. SYSTEM DESCRIPTION

The Barostim *neo*™ system (referred to as *neo* throughout the document) includes the following components:

- Implantable Pulse Generator, Model 2102
- Carotid Sinus Lead, Models 1036 and 1037
- Implant Adapter, Models 5030 and 5033
- Implant Tool, Model 5031
- Programmer System Model 9010 consisting of a Programmer Interface, Programmer Software, and a computer.

The system also includes an Accessory Kit Model 5500, Magnet Model 5000, and Lead Repair Kit Model 5010.

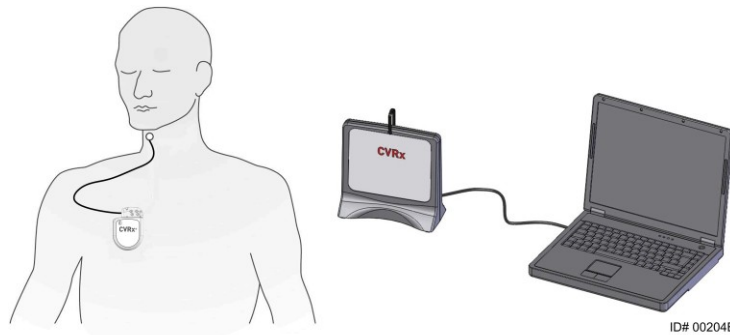

Figure 1: Neo (excluding Implant Adapter and Implant Tool)

The *neo* system is the CVRx next generation system for improving cardiovascular function. The minimally-invasive *neo* system uses CVRx patented Barostim Therapy™ technology to trigger the body’s own natural systems by electrically activating the carotid baroreceptors, the body’s natural cardiovascular regulation sensors. In conditions such as hypertension and heart failure it is believed the baroreceptors, the body’s natural sensors are not functioning properly and are not sending sufficient signals to the brain. This results in the brain sending signals to other parts of the body (heart, blood vessels, kidneys) to constrict the blood vessels, retain water and salt by the kidneys and increase stress-related hormones. When the baroreceptors are activated, signals are sent through neural pathways to the brain. In response the brain works to counteract this stimulation by sending signals to other parts of the body (heart, blood vessels, and kidneys) that relax the blood vessels and inhibit the production of stress-related hormones. These changes act to reduce afterload and enable the heart to increase blood output, while maintaining or reducing its workload.

Implantable Pulse Generator (IPG)

The IPG (Figure 2) contains a battery and circuitry in a hermetic enclosure. It provides control and delivery of the activation energy through the Carotid Sinus Lead to the baroreceptors.

The left or right carotid sinus leads are attached to the pulse generator through the connector module. Nominal dimensions for the IPG are listed in Figure 2.

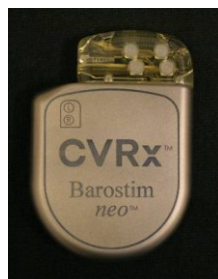

Parameter	Value
Height	72 mm
Width	50 mm
Thickness	14 mm
Mass	60 grams
Volume	< 40cc

Figure 2: Implantable Pulse Generator

Carotid Sinus Leads (CSL)

The Carotid Sinus Leads (Figure 3) conduct the activation energy from the IPG to the baroreceptors located on either the left or right carotid sinus. The leads are available in two (2) lengths Model 1036 (40cm), Model 1037 (50cm). Both are supplied with a 2 mm electrode and an Implant Tool interface. These are fully interchangeable to allow for anatomical variations and to be used per the physician’s discretion.

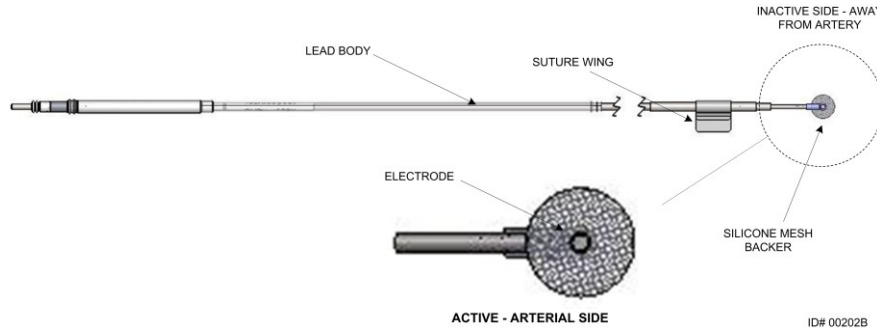
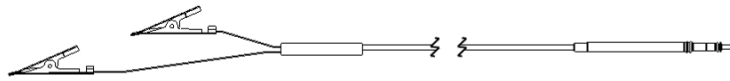

Figure 3: Carotid Sinus Lead

Implant Adapter

The Implant Adapter is a temporary device used at system implant during the electrode mapping process. The therapy circuit requires two connections; the therapy lead and IPG case. The Implant Adapter comes in two variations (Figure 4). The first adapter variation achieves the temporary connections through the header port. In the second adapter variation the therapy lead is connected directly to the IPG header port and the case connection is made via a clip placed on the IPG surface. The adapters are fully interchangeable.

Model 5030 Adapter



Model 5033 Adapter



Figure 4: Implant Adapters

Implant Tool

The implant tool is a temporary device that attaches to the electrode to aid the mapping and implant process. The device integrates into the buckle located on the inactive side of the lead electrode (Figure 5).

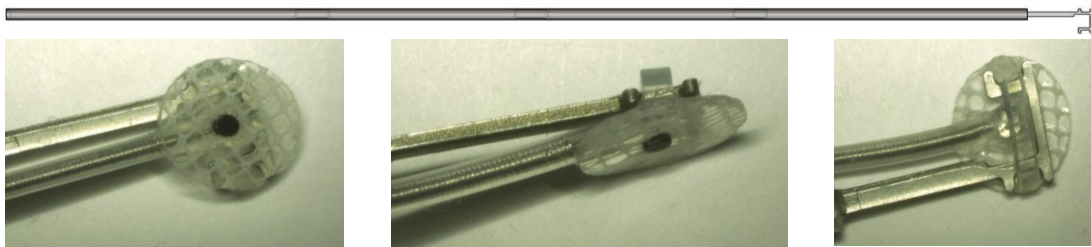

Figure 5: Implant Tool

CVRx Programmer System Model 9010

The Programmer System allows noninvasive communication with the IPG. The Programmer System allows input of therapy parameters and retrieves information regarding the status of the IPG.

The Programmer System consists of the following major components (Figure 6):

- Programmer Software
- Programmer Interface
- Computer

Programmer Software/Computer

The Programmer Software is installed on the supplied computer. A USB memory device is used to facilitate file transfer to and from the computer. The computer with Programmer Software installed allows programming of parameters in the IPG and provides status indicators from the IPG. The Programmer Software will interrogate, adjust, and monitor the therapies being delivered by the IPG.

Programmer Interface

The Programmer Interface provides the telemetry interface to the IPG. It is powered via the USB port on the computer.

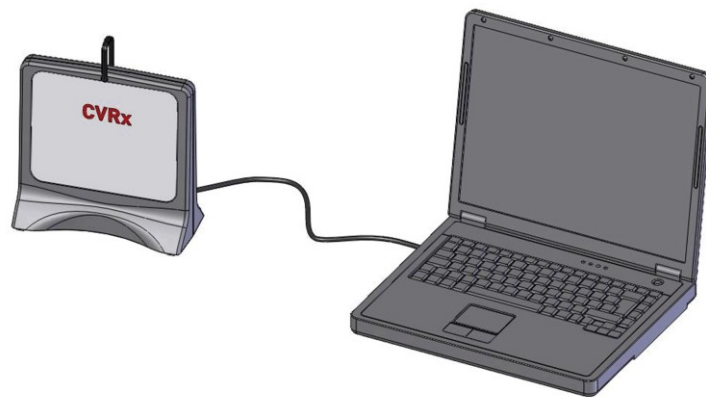

ID# 00205B

Figure 6: Programmer System Model 9010

Optional Accessories for Use with the System

CVRx Magnet

The CVRx Magnet can be used to temporarily inhibit the IPG output by placing the solid part of the magnet over the IPG. The magnet must be kept over the IPG to continue inhibiting the output state. Once the magnet is removed, the output will continue.

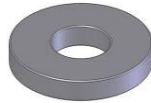

Figure 7: CVRx Magnet

NOTE: The standard round magnets that are distributed for use with pacemakers and ICDs are readily available in both cardiology clinics and hospitals. These can also be used to temporarily inhibit the IPG.

CVRx Accessory Kit

The CVRx Accessory Kit contains a torque wrench and port plug. Use these to replace those provided with the IPG in the event that either the torque wrench or port plug is dropped outside the sterile field.

The torque wrench is used to tighten the setscrews on the IPG. The port plug is used to plug a lead port on the IPG.



Torque Wrench



















Port Plug

Figure 8: CVRx Accessory Kit

CSL Repair Kit Model 5010

The CVRx CSL Repair Kit contains tools and material to repair damage to the insulation and/or conductor coils of the therapy lead after chronic implantation.

2. SYMBOLS AND DEFINITIONS

	Caution, Consult Accompanying Documents
	Consult Operating Instructions
	Do Not Reuse
	Do Not Resterilize
	Temperature Limitation
	Date of Manufacture
	Manufacturer
	Use By Date
	Peel Here
STERILE EO	Sterilized using Ethylene Oxide
	Equipment includes RF transmitter
CE	CE Mark
EC REP	Authorized Rep in the European Community
LOT	Batch Code (Lot Number)
MODEL	Product Model Number
SN	Serial Number
P/N	Part Number
REF	Catalogue Number
CONTENTS	Package Contents
PATENTS	Product Protected by One or More US Patents as listed (International patents and additional patents pending)
	Keep Dry
	This Way Up
	Fragile, Handle with Care
	Do Not Use if Package is Damaged
	WEEE Directive Symbol (Special Disposal Required)
	This Device is Not Intended for the Treatment of Bradycardia or Tachycardia
	OFF; IPG Programmed Mode as Shipped
CVRx System Only	This Device is for Use with CVRx System Only
Intended Use: Neo 2102 + CSL 103x	This Device is for Use with CVRx IPG Model 2102 and Unipolar Lead Models 1036 and 1037 only and not compatible with lead models 101x.

3. INDICATIONS

Barostim *neo* is indicated for patients with heart failure or resistant hypertension.

Resistant hypertension is defined as:

- Blood pressure greater than or equal to **140 mmHg** systolic **and**
- Resistance to maximally tolerated therapy with a diuretic and two other anti-hypertension medications.

Heart Failure is defined as New York Heart Association (NYHA) functional Class III and left ventricular ejection fraction (LVEF) $\leq 35\%$ despite treatment with the appropriate heart failure guideline directed therapy.

4. CONTRAINDICATIONS

Patients are contraindicated if they have:

- Been assessed to have bilateral carotid bifurcations located above the level of the mandible
- Baroreflex failure or autonomic neuropathy
- Uncontrolled, symptomatic cardiac bradyarrhythmias
- Carotid atherosclerosis that is determined by ultrasound or angiographic evaluation greater than 50%
- Ulcerative plaques in the carotid artery as determined by ultrasound or angiographic evaluation

5. WARNINGS AND PRECAUTIONS

General

The safety and effectiveness of Barostim *neo* has been demonstrated in clinical trials.

Warnings

- Only trained physicians may use this system.
- Prescribing physicians should be experienced in the diagnosis and treatment of hypertension and heart failure and should be familiar with the use of this system.
- Monitor blood pressure and heart rate during Carotid Sinus Lead placement and when adjusting stimulation parameters intra-operatively.
- Post-implantation, program the system to avoid the following:
 - Heart rate falls below **50 beats per minute (BPM)**, or
 - Systolic pressure falls below **90 mmHg**, or
 - Diastolic blood pressure falls below **50 mmHg**, or
 - Problematic adjacent tissue stimulation is noted, or
 - Undesirable interaction indicated by monitoring of any other implanted electrical device (see “Device Interaction Testing” in Section 9), or
 - Any other potentially hazardous patient responses are observed
- Do not use Magnetic Resonance Imaging (MRI) on patients implanted with the system.
- Improper system implantation could result in serious injury or death.
- Do not use diathermy therapy including shortwave, microwave, or therapeutic ultrasound diathermy on patients implanted with the system.
- Patients should be counseled to stay at least 15 cm (6 inches) away from devices with strong electrical or magnetic fields such as strong magnets, loudspeaker magnets, Electronic Article Surveillance (EAS) system tag deactivators, arc welders, induction furnaces, and other similar electrical or electromechanical devices. This would include not placing items such as earphones in close proximity to the implanted pulse generator.
- The IPG may affect the operation of other implanted devices such as cardiac defibrillators, pacemakers, or neurological stimulation systems. For patients who currently have an implanted electrical medical device, physicians must verify compatibility with the implanted device during implantation of the system. (see “Device Interaction Testing” in Section 9.)

Precautions

- The system should be implanted and programmed carefully to avoid stimulation of tissues near the electrode or in the area of the IPG pocket. Such extraneous stimulation could involve the following:
 - The regional nerves, causing laryngeal irritation, difficulty swallowing, or dyspnea
 - The cervical musculature, causing intermittent contraction
 - Skeletal muscles, causing intermittent contraction around the IPG pocket
- Proper sterile technique during implantation should be practiced and aggressive pre-operative antibiotics are recommended. Infections related to any implanted device are difficult to treat and may necessitate device explantation.
- Refer to page 20-1 for precautions related to electromagnetic compatibility.

Implantable Pulse Generator

Warnings

- The IPG is a single-use-only device. Do not re-sterilize or reuse. Reuse of this product may result in malfunction or adverse events such as infection or death.
- Do not implant product if the expiration “Use By”  date has been reached.
- Do not implant the IPG if the storage package has been damaged, compromising the product sterility.
- Persons allergic to silicone, titanium, or polyurethane may have an allergic reaction to the IPG.
- Patients who manipulate the IPG through the skin may damage or disconnect the lead from the pulse generator.

Precautions

- This system is compatible with lead models 103x only. Do not use with lead models 101x.
- Do not store the IPG outside the temperature range of -4° F (-20° C) to 122° F (50° C).
- Electrocautery may damage the IPG. Position electrocautery as far as possible from the IPG and items connected to it.
- Do not implant an IPG if the device has been dropped.
- The battery life of the IPG is limited. Patients should be counseled that replacements will be needed.
- IPG operation may cause artifacts in electrocardiogram (ECG) tracings.
- Do not insert a Carotid Sinus Lead in the IPG connector without verifying that setscrews are sufficiently retracted.
- Prior to tightening the setscrews, make sure that lead is fully inserted into the IPG connector module.
- Do not ultrasonically clean the IPG.
- Do not incinerate the IPG. Extreme heat could cause the internal battery to explode.
- Therapeutic radiation may damage the IPG. Damage to the IPG due to therapeutic radiation may not be immediately detectable.
- Lithotripsy procedures can damage the IPG. Position the IPG outside the ultrasound water bath.
- External defibrillation may cause damage to the IPG. During a defibrillation procedure, space electrodes as far as practical from the IPG. Verify proper IPG function after defibrillation procedures. In addition, if it is practical, it is suggested that the IPG be turned off during defibrillation.
- Sterile package seal integrity can be damaged by moisture. Do not expose to liquids.
- If any of these 3 situations is observed, a CVRx representative should be contacted immediately.
 - Low lead impedance, less than 300 Ohms, may indicate a short in the lead.
 - High lead impedance, greater than 3000 Ohms, may indicate poor lead connection to IPG or a lead fracture.
 - Drastic changes in lead impedance may indicate a problem with a lead.
- Do not place the IPG on a magnetic instrument drape. Doing so may place the IPG in an inhibit or “Magnet Mode” which will halt pulse outputs.
- An additional IPG should be available in the event of compromised sterility or if damage is induced during surgery.

Carotid Sinus Lead

Warnings

- The Carotid Sinus Lead is a single-use-only device. Do not re-sterilize or reuse. Reuse of this product may result in malfunction or adverse events such as infection or death.
- Do not implant product if expiration “Use By”  date has been reached.
- Do not implant the Carotid Sinus Lead if the storage package has been damaged, compromising the product sterility.
- This system carries associated risks of lead placement-related trauma to the carotid sinus and surrounding periarterial tissues, including the regional nerves and the jugular and hypoglossal veins.
- Persons allergic to silicone, platinum, iridium, or stainless steel may suffer an allergic reaction to lead placement.
- Only physicians who have appropriate experience in carotid artery surgery and device-specific training should perform placement of the Carotid Sinus Lead.
- Only hospitals where vascular surgery is performed should perform placement of Carotid Sinus Leads.
- Patients who manipulate the Carotid Sinus Lead through the skin may damage or disconnect the lead from the IPG and/or possibly cause damage to the carotid sinus.
- Lead malfunction could cause painful stimulation and/or stimulation of adjacent tissue.

Precautions

- Do not store the Carotid Sinus Lead outside the temperature range of -4° F (-20° C) to 122° F (50° C).
- Sterile package seal integrity can be damaged by moisture. Do not expose to liquids.
- Electrocautery at a low but effective power can be used to minimize the potential of damaging the leads during dissection. Electrocautery at high power settings may damage the Carotid Sinus Lead.
- Scalpels may damage the Carotid Sinus Lead. Avoid scalpel blade contact with the lead when using scalpels.
- Do not implant the Carotid Sinus Lead if the device has been dropped.
- Exercise extreme caution in utilizing line-powered equipment in conjunction with the Carotid Sinus Lead because leakage current could injure the patient.
- Do not use any other lead beside the Carotid Sinus Lead with this system because such use may damage the IPG or injure the patient.
- Additional Carotid Sinus Leads should be available in the event of compromised sterility or if damage is induced during surgery.

CVRx Programmer System**Warning**

- Do not locate any programmer system components inside the sterile operating field.

Precautions

- The components of the Programmer System should not be sterilized.
- The following are requirements to comply with IEC 60601-1 and IEC 60601-1-1:
 - The computer and power supply should be located outside the patient environment when the computer is operated on mains power.
 - The system should not be connected to other non-isolated monitoring equipment or communication networks.
 - The operator should not touch the computer and the patient simultaneously when the computer is operated on mains power.
 - The USB cable should be fully inserted into the Programmer Interface USB receptacle to avoid patient contact with the metal part of the USB connector.

Note: The patient environment is defined as the area within 1.5m (approximately 5ft) of the patient.

- Plug the Programmer System directly into an outlet or operate using the laptop battery power. Do not plug the programmer system into a power strip or extension cord.
- Do not modify the Programmer System (i.e. connect additional equipment via USB) or install additional software. Doing so may result in reduced performance, increased emissions, decreased immunity or equivalent malfunction. Use of a USB Memory Device is acceptable.
- Do not immerse product in water or a safety hazard could arise during use. For cleaning instructions, refer to Section 8, Cleaning the Programmer System.
- Keep the Programmer System in a controlled location to prevent loss or theft. Intentional misuse of the Programmer System could result in an IPG being programmed to settings that are not as prescribed.

CVRx Magnet**Precaution**

- The CVRx Magnet will also engage magnet mode in standard implantable cardiac pacemakers and implantable cardioverter defibrillators (ICDs).

Accessory Kit, Implant Adapter, Implant Tool**Warnings**

- FOR SINGLE USE ONLY. Do not re-sterilize or reuse. Reuse of this product may result in malfunction or adverse events such as infection or death.
- Do not use product if “Use By”  date has been reached.

Precautions

- Store between -4° F (-20° C) and 122° F (50° C).
- Do not use if the storage package has been damaged, compromising the product sterility.
- Sterile package seal integrity can be damaged by moisture. Do not expose to liquids.

6. ADVERSE EVENTS

It is anticipated that subjects will be exposed to operative and post-operative risks similar to related surgical procedures involving the neck and/or a pacemaker implant. These risks and potential risks of chronic device based baroreflex activation may include, but are not limited to:

- Stroke – a neurological deficit lasting more than 24 hours or less than 24 hours with a brain imaging study showing infarction
- Transient ischemic attack (TIA) – a neurological deficit lasting less than 24 hours without evidence of permanent cerebral infarction
- Systemic embolization – downstream obstruction of a blood vessel by migration of loosened intravascular plaque or clot
- Surgical or anesthetic complications
- Infection – the need for antibiotics or possible removal of the system
- Wound Complication – including hematoma (i.e. bruising and/or swelling)
- Arterial damage – including carotid artery rupture or hemorrhage (sudden and significant blood loss at a site of blood vessel rupture that may require reoperation or transfusion)
- Pain – an unpleasant sensory experience
- Nerve Damage/Stimulation – including injury to or stimulation of Cranial, Marginal Mandibular, Glossopharyngeal, Recurrent Laryngeal, Vagus and Hypoglossal Nerves (numbness in head and neck, facial palsy/paralysis, altered speech, altered sense of taste, respiratory constriction, stertorous breathing, excessive salivation, dry cough, vomiting and/or regurgitation, altered sensory and motor function of tongue, altered sensory function of pharynx and oropharynx, altered sensation in external auditory canal), stimulation of extravascular tissue (muscle twitching (fasciculation), pain, tingling, oral sensations)
- Hypotension – a decrease in systolic and diastolic blood pressure below normal levels that may result in dizziness, fainting, and/or falls
- Hypertensive crisis – uncontrolled rise in blood pressure
- Respiratory – including low oxygen saturation, respiratory distress, shortness of breath
- Exacerbation of heart failure
- Cardiac arrhythmias
- Tissue erosion/IPG migration – movement of device resulting in need for reoperation
- Injury to baroreceptors – an injury that results in baroreflex failure
- Fibrosis – replacement of normal tissue by the ingrowth of fibroblasts and the deposition of connective tissue
- Allergic Reaction
- General injury to user or patient – may be due to surgical procedure, device use, or interaction with other devices
- Need for reoperation – operation to explant/replace IPG or CSLs due to tissue damage, infection, and/or device failure
- Secondary operative procedure – An increase in the complexity and risk of secondary operative procedures of the neck due to scar tissue and the presence of prosthetic material implanted for this device.
- Death

7. PHYSICIAN TRAINING AND EXPERIENCE

CVRx requires training for physicians who wish to use this system.

8. SYSTEM PREPARATION

How Supplied

The implantable components of the system and implant accessories have been sterilized using ethylene oxide gas. CVRx has supplied these components in a sterile package for direct introduction into the operating field.

Implantable Pulse Generator

Supplied in a single package as a kit with the following configuration:

- One sterile IPG Model 2102 with therapy **OFF**.
- One sterile port plug
- One sterile torque wrench.

Carotid Sinus Lead

Supplied in a single package as a kit with the following configuration:

- Either one sterile CSL Model 1036 or one sterile CSL Model 1037
- Either one sterile Implant Adapter Model 5030 or one sterile Implant Adapter Model 5033
- One sterile Implant Tool, Model 5031

Implant Accessories

Supplied in a single package as a kit with the following configuration:

- One sterile port plug
- One sterile torque wrench

Programmer System

Programmer Interface Model 9010 with USB cable.

The Programmer Software is to be installed on a computer equipped with a USB interface.

Inspection Prior to Use

Implantable Pulse Generator

Carefully inspect the IPG sterile package before opening.

The implantable components are supplied **STERILE** and for **SINGLE USE**. Do not use if the package is opened or damaged. Return the package and/or contents to CVRx. Reuse of this product may result in malfunction or adverse events such as infection or death.

Do not use on or after the “Use By”  date. Return the unopened package to CVRx.

Before opening the IPG package, establish a communication session with the IPG. If the reported battery voltage is less than 2.85V, return the package, unopened, to CVRx.

Carotid Sinus Lead, Implant Adapter, and Implant Tool

Carefully inspect the CSL and Implant accessories sterile package before opening.

The implantable components are supplied **STERILE** and for **SINGLE USE**. Do not use if the package is opened or damaged. Return the package and/or contents to CVRx. Reuse of this product may result in malfunction, or adverse events such as infection or death.

Do not use on or after the “Use By”  date. Return the unopened package to CVRx.

Materials Recommended for Implantation and/or Explantation

- A table or stand outside the sterile operating field to hold the Programmer System
- Blood pressure monitoring equipment (such as an arterial line) for assessment of blood pressure changes during therapy testing.
- Optional Accessories
 - CVRx Accessory Kit, Model 5500

Cleaning the Programmer System

If the Programmer System requires cleaning, clean the system components with a soft cloth dampened with water. Do not allow pooling or ingress of liquid into the Programmer Interface enclosure.

Programmer System Set Up

Insert the USB I/O cable connector into the USB I/O port on the Programmer Interface by pushing the connector into the port until it clicks into place. Make sure the connection is secure.

Insert the USB I/O cable into any empty USB port on the computer to connect the Programmer Interface. Make sure the connection is secure.

NOTE: The cables can be connected with the computer powered ON or OFF.

Confirm that Programmer Interface is connected correctly by checking to see if the green light on the Programmer Interface is lit.

9. PROGRAMMER SYSTEM OPERATION

The Programmer System can be used to:

- Interrogate, adjust, and monitor the therapies being delivered by the IPG
- Monitor IPG status information such as battery voltage and end of service indicators

Navigating

Use the pointing device to navigate the Programmer Software. In this section, the word “click” indicates depressing the left pointing device button to perform the required action.

User Login

After powering up the programmer you will be requested to login. Click the CVRx User and enter the password.

Language and Region Selection

The Programmer System can be configured to operate in one of several language and regionalization configurations. Use the Language and Region Selector application to select the desired configuration. Open the Language and Region Selector by clicking on the Windows Start icon in the lower left corner of the screen and selecting “Language and Region Selector” from the Start menu. A list of items made up of language followed by country or region is displayed, as in Figure 9.

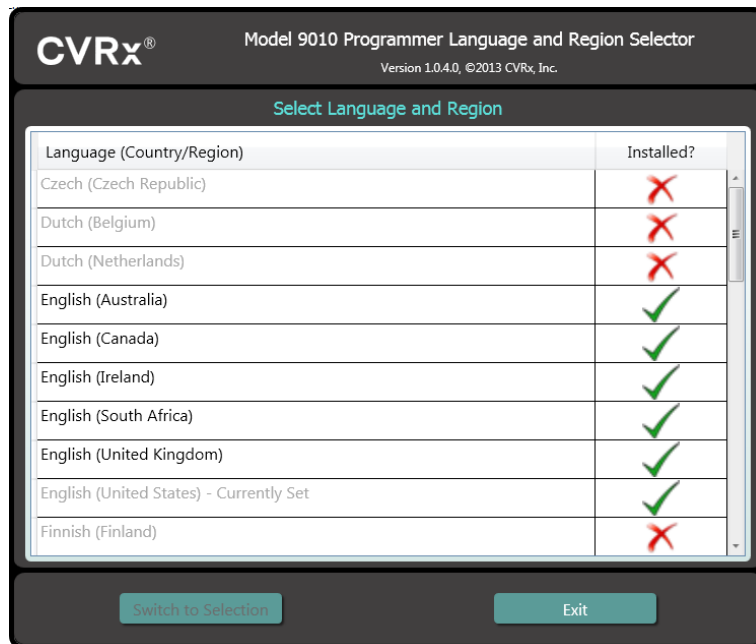

Figure 9: Language and Region Selector Screen

Scroll through the list to find the desired setting, click the row containing the setting, and click “Switch to Selection”. If the selected language differs from the current language, the PC will reboot. If the desired language is not available, a language pack installer needs to be obtained from your local CVRx representative or distributor.

Starting the Application

Double-click the “CVRx” icon labeled “CVRx Launcher” to start the software application.

NOTE: When the software is started, it automatically looks for the Programmer Interface. If the software cannot find the Programmer Interface, a warning message will be displayed. Plug the Programmer Interface into the computer USB port before continuing.

Connection Dialog

When the Connection Dialog window appears, verify that the system time, date, and time zone on the programmer is correct. If not, click the **Set...** button to correct the time.

The Discovery status should indicate **In progress...** While Discovery is in progress, all CVRx RF enabled IPG devices within telemetry range will be displayed in the list of IPGs discovered.

In order to establish communication, first select the device by clicking on the row containing the desired patient identification and serial number information. This will highlight the row. Ensure that the patient identification and serial number of the selected IPG matches that of the device implanted in the patient being treated. If an incorrect device is selected, a telemetry link will be established with an IPG that is not the one implanted in the patient being treated.

Note: If the desired IPG does not appear on the list, move the Programmer Interface closer to the patient until the device appears.

After the proper IPG is selected, click on the **Connect** button to start communication. The application will then display the Main Screen.

The IPG is automatically interrogated by the Software Application so that the current device settings are always available.

If an IPG error is encountered, a device error status will be displayed.

An automated adjustment of the IPG day clock takes place at the beginning of a session. The software sets the time of day clock/calendar of the IPG equal to the computer time of day clock/calendar.

Main Screen

The Main Screen of the application contains the Patient Identification, IPG Status, Therapy Settings, and Schedule windows. This screen provides a view of all pertinent therapy related settings. It also provides the Session Notes space to allow entry of any notes to be included in the Session Summary Report. The Session Summary Report, which contains the final therapy parameters and all pertinent session information, can be generated by clicking the **Save Report...** button. When the communication session is completed, the user can press **End Session...** This returns the software to the Device Selection Screen.

Patient Identification

The software displays the patient identification along with IPG model and serial numbers in the Patient Identification window. The patient identification information can be changed by clicking on the **Edit...** button. Both Patient Name and Patient ID can be stored.

Note: For privacy reasons, Patient Name will not appear on saved reports.

Note: There are times when the keyboard must be used to enter information. In some locations, the keyboard layout in use may be different than what is shown on the laptop keys. A locale specific on-screen

keyboard can be produced by clicking the  icon whenever it is visible. This keyboard can also be repositioned on the screen to aid in data entry.

IPG Status

The IPG Status window is always active and provides several pieces of information related to the current status of the IPG.

Current Therapy Status

The Therapy Status is a real-time display that shows information about therapy being delivered by the IPG. **No Therapy** indicates that no therapy is being delivered.

Quickly–Stopping All Applied Therapies

In case of patient discomfort or safety concern, ensure a good telemetry signal exists and select the **Stop** button, next to the symbol ⛔, in the software to immediately stop all therapies. To start therapy output, press the **Resume** button, which is in the same screen location.

Refer to the Emergency Personnel Information in section 14 of this Reference Guide for additional information regarding nonprogrammer-based suspension of therapies, including magnet use.

Battery Life

The software displays an estimate of the expected life remaining of the IPG battery, the date of the Recommended Replacement Time (RRT), and the current battery voltage. The battery life estimation is based on the currently programmed permanent therapy and schedule settings. The device should be scheduled for replacement on or before the RRT to prevent loss of therapy. If the RRT date has already passed, the Battery Life status box turns yellow and indicates **RRT Alert**. The battery voltage displayed may decrease during a communication session due to the high power requirements of telemetry as well as impacts of aggressive parameter settings used during testing of therapy efficacy.

Lead Impedance

The impedance of the lead(s) is displayed in the Lead Impedance portion of IPG Status. Make an immediate lead impedance measurement by clicking on the ∪ symbol in Lead Impedance. The lead impedance values provide a measure of lead integrity and can indicate whether therapy delivery is functioning properly. Impedance measurement results from unused or plugged connector ports are not meaningful.

Precaution: If any of these 3 situations is observed, a CVRx representative should be contacted immediately.

- Low lead impedance, less than 300 Ohms, may indicate a short in the lead.
- High lead impedance, greater than 3000 Ohms, may indicate poor lead connection to IPG or a lead fracture.
- Drastic, abrupt or sudden changes in lead impedance may indicate a problem with a lead.

NOTE: Lead Impedance values measured after the IPG reaches EOS may be lower than the actual impedances.

Confirming a Good Telemetry Link

It is important to confirm that there is a good telemetry link between the Programmer Interface and the IPG after selecting the IPG.

In order to get a good telemetry signal, ensure that the Programmer Interface is placed in its upright position with no obstructions between the Programmer Interface and the IPG. Telemetry performance is best when the Programmer Interface front or back side label is facing the IPG and is a distance of 2 meters or less from the IPG.

Check the quality of the telemetry link between the Programmer Interface and the IPG by looking at the Link Quality Indicator (Figure 10) on the Software Application screen. Two or more green bars are required in order to ensure that parameter updates occur in the IPG when requested.



Figure 10: Link Quality Indicator (Excellent, Poor, No Link)

The 9010 Programmer Interface has the option to be hung from an IV pole using the provided hook. This configuration may improve the quality of the telemetry link in situations where the link is difficult to maintain.

Therapy Settings

The system has up to three independently programmable therapies (Therapies 1, 2, 3). Each therapy has its own status window. Each Therapy status window contains a therapy status indicator, the therapy settings, and an **Edit and Test...** button. Therapy settings can be changed by clicking the **Edit and Test...** button.

Therapies have independent control of the parameters in Table 1.

Changing a Parameter Setting

Table 1: Parameter Settings

Parameter	Description	Range of Values
Pathway	Determines the position of applied pulses for the therapy.	Left, Right, Both
Pulse Width	Determines the width of the applied pulse. Can be configured individually for the left and right pathways.	15 microseconds to 500 microseconds
Amplitude	Determines the amplitude of the applied pulses. Can be configured individually for the left and right pathways.	0.8 milliamps to 20.0 milliamps
Therapy Frequency	Determines the frequency of applied pulses except during the Rest portion of the Burst Interval.	10 to 100 pulses per second
Burst Enable	Determines whether therapy pulses are applied throughout the burst cycle in a continuous manner or if a cycle of active and rest periods is being used.	On, Off
Burst Duration	Determines the length of the active portion of the burst cycle during which the Therapy Frequency is delivered. NOTE: This parameter is not shown if Burst Enable is Off.	50 milliseconds to 1950 milliseconds
Burst Interval	Determines the total length of the burst cycle including the active portion and the rest portion. NOTE: This parameter is not shown if Burst Enable is Off.	100 milliseconds to 2000 milliseconds

The Compliance column of each therapy provides an indication of the Compliance of each pathway. Compliance is measured when therapies are tested on the **Edit and Test...** screen. The Compliance indication can be one of the following:

- “---” No Compliance measurement has been taken
- “✓” IPG is able to deliver programmed amplitude
- “✗” IPG is not able to deliver programmed amplitude

Compliance is a measure of the ability of the IPG to deliver the programmed output amplitude. The IPG delivers output pulses that maintain a constant electrical current during the duration of each pulse. There are situations in which the device cannot maintain this constant current. When this occurs, the device will not

deliver the programmed amplitude throughout the duration of the pulse and Compliance will fail. Settings that are out of Compliance cannot be saved in the IPG.

NOTE: All therapies with pathways enabled must be evaluated for Compliance at each follow-up so that the proper settings are sent to the IPG. This should be performed even if the therapy settings are not being changed.

Edit and Test Screen

The **Edit and Test** Screen is used to adjust therapy settings and record therapy effectiveness. Follow these steps to adjust, assess, and program therapy settings:

- 1) Select desired therapy settings and test mode in the **Therapy N** window.
- 2) Click the **Test Now** button to start delivery of the desired settings.
- 3) Use the Elapsed Time to determine when to perform a blood pressure measurement.
- 4) If testing is complete click **Record** to add the entry to the Patient Response Log.
- 5) If more testing needs to be performed, go back to Step 1.
- 6) BP, Heart Rate, and any observational notes on any entry in the list can be entered at any time by double clicking on the box containing the information.
- 7) Select the Patient Response Log entry containing the final desired settings for the therapy.
- 8) Click **Save Selected Log Entry as Therapy N** to program the settings for **Therapy N**.

The **Therapy N** window contains a group of parameter settings that can be used to evaluate therapy efficacy. Use the Pathway check boxes to control which channels will be assessed. Adjust Pulse Width, Amplitude and Frequency, and Burst parameters to the desired settings.

Click **Test Now** to transmit the settings in the **Therapy N** window to the IPG. The settings are transferred to the Pulse Parameters section of the Patient Response Log window and the Elapsed Time is restarted. If a test is currently in progress, these current settings and compliance results will be added to the Patient Response Log when **Test Now** is pressed.

Click **Stop Test** to stop therapy, allowing observation of the patient response without therapy. Therapy is disabled as reflected in the Pulse Parameters section of the Patient Response Log window. A Patient Response Log entry is automatically added with a note indicating the therapy was stopped. The Elapsed Time is restarted.

The Patient Response Log window allows monitoring of Compliance during the test and provides the Elapsed Time since the settings were invoked.

NOTE: If a Compliance check fails when using aggressive therapy settings, first adjust the Amplitude downward until the Compliance check passes. If further reduction of Amplitude is not desired, reducing Pulse Width may allow the Compliance check to pass. Also, be sure the lead impedance for the channel being tested is in a normal range.

The Patient Response Log window also provides an estimation of the battery life utilizing the parameters being tested. This estimate does not take the Therapy Schedule into account. Instead, therapies under test always assume a 24 hour schedule. This allows comparison of the current settings to other settings that have been tested. However, these estimates should not be compared to the Battery Life estimate in the IPG Status section at the top of the screen. The Battery Life estimate in IPG Status always represents the longevity of the currently programmed permanent parameter settings.

Clicking the **Record** button adds an entry to the Patient Response Log. An entry can be selected by clicking somewhere on the desired entry in the log. The selected entry is highlighted. A vertical scroll bar will appear to the right of the entry list if there are more entries than can be displayed. Use the scroll bar to find the desired entry if it isn't visible. Measured results for BP and Heart Rate, as well as any observational notes that are related to the therapy settings, can be entered by clicking on the box of interest and entering the information. (Note that the on-screen keyboard can be used to aid data entry.) The selected entry can be removed by clicking the **X** button. All edits and deletions are permanent. Click the **Use Selected Log**

Entry for Test button to load the settings of the selected Patient Response Log entry into the **Therapy N** window. This provides convenient access to prior settings if more testing is desired.

There are two options to return to the Main Screen.

- Select the permanent therapy settings by choosing a Patient Log Entry that contains the desired settings and also indicates that Compliance has passed on all active pathways. Then press the **Save Selected Log Entry as Therapy N** button.
- If no permanent changes are to be made, choose **Exit without Saving**.

NOTE: All therapies used in the Therapy Schedule should be evaluated for compliance and re-saved as the permanent therapy if the compliance result has not passed.

Adjusting the Schedule

The Schedule controls the portion of each day during which therapy is delivered. The Schedule is a 24 hour clock that is started at midnight each day. The current Schedule settings are displayed in the Schedule window (see Figure 11 for an example).

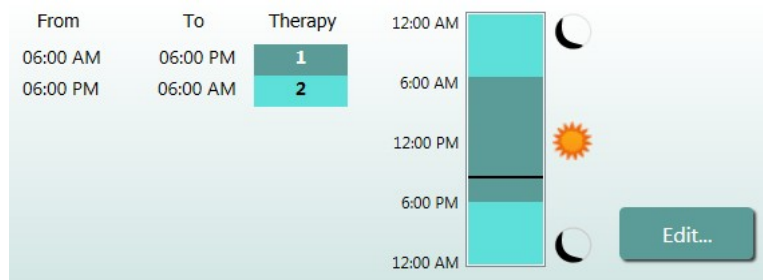

Figure 11: Example Schedule

Click on the **Edit...** button in the Schedule window to set and adjust time of day when therapy will be delivered. The Schedule contains a list of entries. Each entry is defined by a time period and the Therapy assigned to it. **Off** should be selected if periods of no therapy are desired. Click **Save** to program Schedule changes or **Cancel** to ignore changes.

Note: The IPG Schedule is in relation to the local time set by the programmer computer. Patients who travel to other time zones and have more than one therapy in their Schedule will experience therapy transitions based on the time zone in use at the time of IPG programming. If the patient travels to a different time zone, the IPG schedule does not change to the new time zone. Clinicians should take this behavior into consideration when programming multiple therapies.

IPG Diagnostics

Use the **IPG Diagnostics...** button on the Main Screen to navigate to the Management Center screen.

This screen provides the following information:

- Versions of embedded firmware
- The date and time EOS was encountered (N/A if EOS has not occurred).
- The times of the measurements of the maximum and minimum battery voltages.

The file created when pressing the **Save IPG Diagnostics** button may be requested by CVRx.

Estimating Longevity of Implantable Pulse Generator

The battery lifetime of the IPG is dependent on device therapy settings. For example a 24-hour therapy with 20 Hz therapy frequency, unilateral output pathway, 125 μs pulse width, and 6.0mA pulse amplitude into a 650 Ohm load will yield estimated device longevity of approximately 66 months. Follow-up frequency for each patient should be adjusted based on the longevity results of each follow-up such that the next follow-up occurs no later than half of the number of months to predicted RRT when RRT is greater than 3 months away. When RRT is less than 3 months away, it is recommended that replacement be scheduled on or before the RRT to prevent battery depletion.

NOTE: The longevity estimates provided in this section give the time from the start of therapy to the RRT for the device.

Table 2 contains the estimated device longevity for a variety of parameter sets dependent upon the lead model implanted. For these calculations, a single 24-hour therapy was assumed.

Table 2: Effect of Parameter Changes on Device Longevity (listed in months)

Pulse Amplitude (mA)	Pulse Width (us)	Therapy Frequency (Hz)	Device Longevity (Unilateral)
6.0	125	20	66
8.0	125	20	50
6.0	65	20	87
8.0	65	20	72
6.0	190	20	52
8.0	190	20	38
6.0	250	20	43
8.0	250	20	31
6.0	125	40	43
8.0	125	40	31
6.0	65	40	66
8.0	65	40	50

Under worst case longevity programming conditions of a 24-hour therapy with 40 Hz therapy frequency, unilateral output pathway, 250 μs pulse width, and 8mA pulse amplitude into a 650 Ohm load, device longevity is expected to be approximately 17 months.

Device Interaction Testing

The IPG may affect the operation of other implanted devices such as cardiac defibrillators, pacemakers, or neurological stimulators. For patients who currently have an implanted electrical medical device, compatibility between the *neo* IPG and the other implanted electrical device must be verified whenever settings are changed in either implant.

Interactions are more likely in devices that contain a sensing function, such as an implantable cardiac defibrillator or pacemaker. Refer to the manufacturer’s documentation regarding evaluation of sensing performance in such devices. If an interaction is observed, the *neo* IPG should be programmed to reduced therapy output settings in order to eliminate the interaction. If necessary, change settings in the other implant only if the changes are not expected to negatively impact its ability to perform its prescribed therapy. During the implant procedure, if problematic device interactions cannot be eliminated the Neo system should not be implanted.

10. IMPLANTATION PROCEDURE

Before Implantation

Formal preoperative duplex ultrasonography should confirm the absence of complex arterial anatomy, such as carotid kinks, loops and coils, which would compromise the implant procedure.

- Verify absence of any stenosis producing a greater than 50% reduction in diameter of the carotid arteries.
- Verify absence of any ulcerative plaques.
- Verify the level of the carotid bifurcation is easily accessible from standard cervical incisions.
- Determine if there are any anatomic variants present which might suggest that additional imaging would be helpful for treatment planning.

It is generally recommended that patients taking beta-blockers preoperatively continue these on the day of surgery. If the patient has bradycardia consider reducing the beta-blocker dose preoperatively as some anesthetic agents used for the implant procedure may also lower the patient's heart rate. If the patient is hypertensive, antihypertensive medications, particularly centrally acting alpha-adrenergic agents are withheld until after the implant, if it is judged that this would not reasonably compromise safety. The patient's blood pressure should be maintained near baseline which may be facilitated with intravenous nitroglycerine or nitroprusside. If clonidine is withheld it can be given in the postoperative period, as the patient's blood pressure allows to avoid the rebound hypertension that may be seen with acute clonidine withdrawal.

On the day of surgery, the level of the bifurcation may be marked to facilitate incision placement.

Ensure that a backup Programmer System is available in case the primary system is damaged or becomes non-operational.

For patients who currently have an implanted electrical medical device an interaction study must be performed during the implantation procedure. Ensure that proper instrumentation for monitoring the behavior of the currently implanted device is present.

System Implantation

Surgical approach and techniques for the implantation of the system will vary with the preference of the implanting surgeon. Essential requirements for proper and safe implantation of the system must include the items covered in this section.

Throughout the implantation procedure, continuously monitor the patient's blood pressure using an arterial line.

Skin Preparation

Skin preparation should be performed immediately before applying the surgical drapes with an agent that is effective against typical skin flora. After skin preparation, application of an impermeable skin barrier, such as 3M™ Ioban™ (3M, St. Paul, MN) is recommended for cervical and thoracic surgical incision sites to minimize contact between the implanted components and the patient's skin. If this or similar products are used, consideration should be made for using 3M™ DuraPrep™ as the final skin preparation. The use of this product is associated with more reliable fixation of the skin barrier to the skin throughout the implantation procedure.

Antibiotic Coverage

As with any surgical procedure, infection control is important. It is recommended that antibiotic coverage be administered in the perioperative period. The specific antimicrobial agent chosen should be based on the published pathogen antimicrobial susceptibilities of the implanting institution and should cover staphylococcal species. Drug dosage and timing of administration should be chosen to guarantee high tissue levels at the time the skin incisions are made. The antibiotic must be continued at effective doses for 24 hours postoperatively, adjusted for renal function as necessary. Consideration for a second dose of antibiotics during the implantation procedure should be based on the half-life of the antibiotic and the length of the implantation procedure.

Anesthesia

Implants require anesthetic management that preserves the baroreflex during the electrode placement portion of the procedure. Consequently, special care must be used during the procedure with regard to administering anesthesia. The main goal of the anesthesia is to ensure patient comfort during surgery while minimizing blunting of the baroreflex response during the mapping process for identifying the appropriate electrode implant location and allowing the patient to respond to sensation from electrical stimulation of the sinus during the mapping process.

The implantation procedure may be performed under either a total intravenous (TIVA) general anesthesia regimen or a conscious sedation regimen with a superficial cervical plexus block. The two regimens use a similar protocol and similar anesthetic agents, except for disparate dosages and the use of a superficial cervical block. The conscious sedation regimen with a superficial cervical plexus block is intended to allow for monitoring patient responses to sensations during the mapping process and to avoid intubation. The anesthetic regimen used should be carefully considered by the implanting surgeon and anesthesiologist with attention to which may offer the best option for each patient.

The procedure is divided into the following three main phases: 1) from the skin incision to exposure of carotid bifurcation/sinus; 2) carotid sinus mapping and system testing; 3) pocket creation, tunneling and wound closure.

During exposure of the carotid bifurcation/sinus (i.e. the first phase), agents such as narcotics, benzodiazepines, barbiturates and local anesthetics that minimize blunting of the baroreflex may be used. To date, the preferred opioid has been remifentanyl due to its short half life and ability to titrate the dose to the patients needs. Remifentanyl does induce bradycardia at higher doses; therefore morphine administration may help reduce the infusion rate of remifentanyl required during the case and improves analgesia upon emergence from anesthesia. In preparation for the mapping procedure, the anesthesia may be adjusted to facilitate successful mapping. This may include reduction of narcotic as dictated by heart rate and the infusion rate of the benzodiazepine and/or barbiturate agents while maintaining adequate anesthetic depth to avoid recall (in the general anesthesia regimen).

During mapping and electrode attachment (i.e. the second phase), anesthesia levels should be as stable as possible. Continued use of narcotics, benzodiazepines, and barbiturates that minimize blunting of the baroreflexes may be employed during this phase. The use of atropine or glycopyrrolate should be avoided unless patient safety requires as these may abolish some of the response to activation of the carotid baroreflex making mapping and the determination of the optimal location of the carotid sinus electrode more difficult.

Once the best electrode location has been determined, the electrode fully affixed to the vessel, and baroreflex testing completed (i.e. phase 2 is complete), agents such as Isoflurane, Desflurane, Sevoflurane, propofol and dexmedetomidine may be used during pocket creation, tunneling and wound closure (i.e. the third phase) to achieve adequate levels of anesthesia. Additionally, nitrous oxide has been used successfully as a supplement to other anesthetics during all phases of the implantation procedure and may be helpful in reducing the cumulative doses of midazolam or barbiturates and reducing the risk of recall.

If the conscious sedation regimen is used, efforts should be made to avoid deep cervical blocks, which could impair mapping by abolishing the carotid baroreflex. Also, avoid directly injecting local anesthetic (e.g. lidocaine) into the carotid artery.

Opening the Sterile Package

NOTE: Determine lead length required based upon patient anatomy.

Prior to opening, the package should be inspected for evidence of damage or compromised sterility.

Do not open the system package if it has been exposed to extremes of temperature outside of the temperature range stated on the labeling, or if there is damage to the package or the package seal. Return the package, unopened, to CVRx.

Prior to opening the IPG package, establish a communication session with the IPG. If the reported battery voltage is less than 2.85V return the package, unopened, to CVRx.

The IPG, Carotid Sinus Leads, Implant Adapter, and Implant Tool are supplied **STERILE** and for **SINGLE USE**. Do not use if the package is opened or damaged. Reuse of this product may result in malfunction, adverse event or death.

To open the package, do the following:

- 1) Grasp the tab and peel back the outer cover.
- 2) Using sterile technique, lift out the inner tray.
- 3) Grasp the tab on the inner tray and peel off the inner cover to expose the contents.
- 4) Remove the product.

Implantation and Mapping Procedure

NOTE: While handling the CSL, do not grasp the lead body or active area of the electrode with metal clamps or forceps. The Implant Tool is provided as a means for handling and controlling the electrode.

NOTE: During carotid sinus mapping and testing, particularly under general anesthesia, bradycardia may be induced at higher stimulus intensities. Bradycardia should terminate when therapy is stopped. This may be accomplished as follows:

- by pressing the **Stop Test** button during mapping; or
- by removing the electrode from the carotid sinus.

The following procedure steps identify a framework for a unilateral, reduced incision surgical protocol (<1 inch or 2-3 cm skin incision) for performing the implant of the system. Actual implant steps and extent of the incisions/dissection required may be modified from this outline as directed by the implanting surgeon to ensure a successful implant and account for any patient variability.

The steps below are defined for a unilateral implant with one CSL. It is recommended that the CSL and IPG be implanted on the same side to minimize the extent of tunneling. However, the lead may be placed contralateral from the IPG if required (50 cm lead will be required). The location of the CSL and IPG is at the discretion of the implanting surgeon.

- 1) Arterial line for continuous hemodynamic monitoring and other invasive or non-invasive instrumentation for hemodynamic assessment.
- 2) Prepare and drape patient for surgery.
- 3) Position patient head and neck to simulate position necessary for surgery. Position identified from preoperative evaluations (e.g. duplex ultrasonography) and surgeon discretion.
- 4) Prior to performing initial incision, use ultrasound to identify and mark the level of the carotid bifurcation and to identify the facial vein (facial vein is a cross-check to assure that the flow divider has been identified correctly). In addition, characterize the carotid sinus if possible.
 - This pre-incision ultrasound evaluation is critical in identifying the location and reducing incision size.
- 5) Make a 1 inch (2-3 cm) incision in the skin centered on the carotid sinus (vertical or oblique).
- 6) Carry the incision through the subcutaneous tissues and platysma.

- Use of a retractor (e.g. Henley) may be helpful during dissection in small incision.
- 7) The medial aspect of the SCM is dissected free.
 - 8) If necessary, ligate and divide the facial vein, after checking for an aberrant hypoglossal nerve.
 - 9) The SCM is then retracted laterally to expose the carotid sinus.
 - 10) Identify and protect the internal jugular vein.
 - 11) Expose the superficial aspect of the common carotid artery and dissect along the superficial aspect of the carotid sinus. Complete circumferential mobilization of the carotid bifurcation is not required for the implantation procedure because, at most, the portion of the carotid sinus not in contact with the carotid bifurcation will be mapped. Therefore, complete circumferential dissection of the internal, external and common carotid arteries is not advised for the implantation procedure.
 - **Do not dissect the tissues between the internal and external carotid arteries (i.e. carotid notch).**
 - 12) Expose the carotid sinus for electrode mapping and final placement. Observations from the Rheos pivotal trial as well as preclinical studies suggest that it may be beneficial to fully remove the peri-adventitial layer (exposing the adventitial layer) in the locations for mapping. This is accomplished by dissecting along the plane that is easily developed along the surface of the carotid artery and removing the areolar tissues that easily dissects away from the vessels.
 - Mapping and electrode fixation require only superficial exposure of the carotid sinus as well as superficial exposure of the common carotid artery nearest to the carotid sinus. Typically, superficial exposure of the common carotid artery extends 1 to 1.5 cm below the carotid sinus. During this process, avoid dissection within the bifurcation (tissues between the internal and external carotid arteries), identify and protect the Vagus and Hypoglossal nerves, and minimize manipulation of the carotid sinus and bifurcation.
 - During this dissection the arteries may tend to arch into a more superficial location and rotate slightly. At times this will result in the arteries buckling so that the dissection will need to be extended to the full extent allowed by the incision to allow for a gentler arch for this transition.
 - The carotid sinus may not be located directly at the bifurcation; it may reside inferior, superior, or at the level of the bifurcation.
 - 13) **Directions for use when using Implant Adapter 5030:**

When the carotid sinus exposure is complete, preparations are then made for mapping. Local anesthesia is injected into the dermis of the skin producing a raised area. Insert a 16 to 18 gauge introducer needle (a minimum of 2 inches in length) into the subcutaneous tissues in the IPG pocket region. Note that the needle should lie approximately parallel to the skin in the subcutaneous tissues and not perpendicular to the skin. Connect Implant Adapter (Model 5030) to both the lead terminal pin and metal portion of needle. Connect the Implant Adapter terminal into the IPG header and tighten the setscrews using the torque wrench (2 setscrews are required for electrical contact). Refer to Figure 12. Inject saline into needle to provide sufficient contact of needle and tissue.

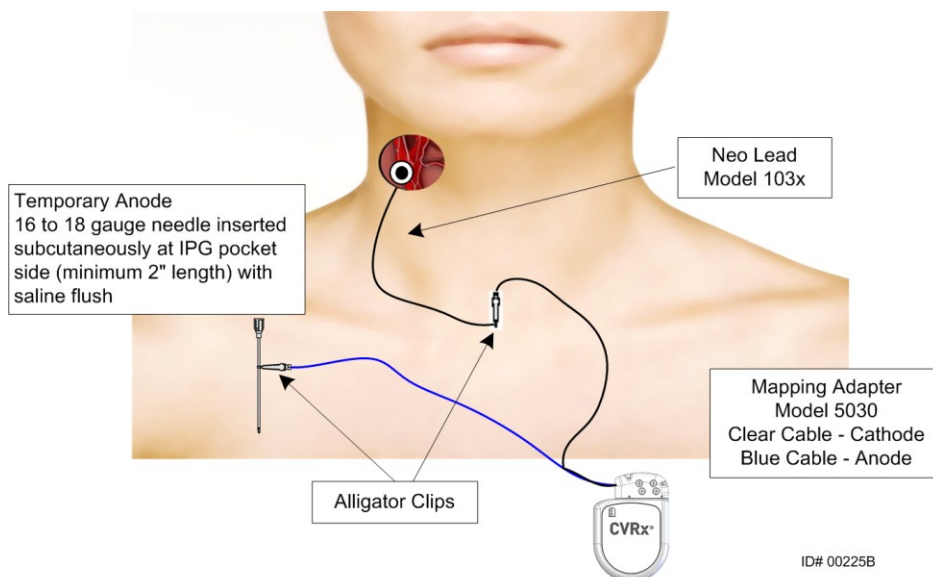

Figure 12: System Mapping Configuration for Implant Adapter Model 5030

14) Directions for use when using Implant Adapter 5033.

When the carotid sinus exposure is complete, preparations are then made for mapping. Insert a 16 to 18 gauge introducer needle (a minimum of 2 inches in length) into the subcutaneous tissues in the IPG pocket region. Note that the needle should lie approximately parallel to the skin in the subcutaneous tissues and not perpendicular to the skin. Connect the lead to be mapped into the preferred IPG header block location (right or left) and tighten both setscrews using the torque wrench (2 setscrews are required for electrical contact). Slide the clip of the Implant Adapter over the main body (metal portion) of the IPG can. Then connect the alligator clip from the Implant Adapter to the metal portion of needle. Refer to Figure 13. Inject saline into needle to provide sufficient contact of needle and tissue.

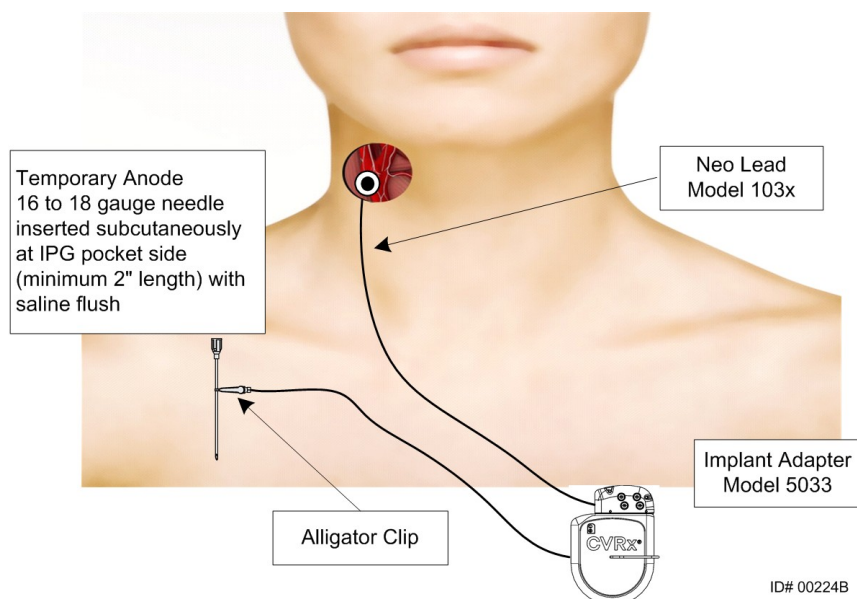

Figure 13: System Mapping Configuration for Implant Adapter Model 5033

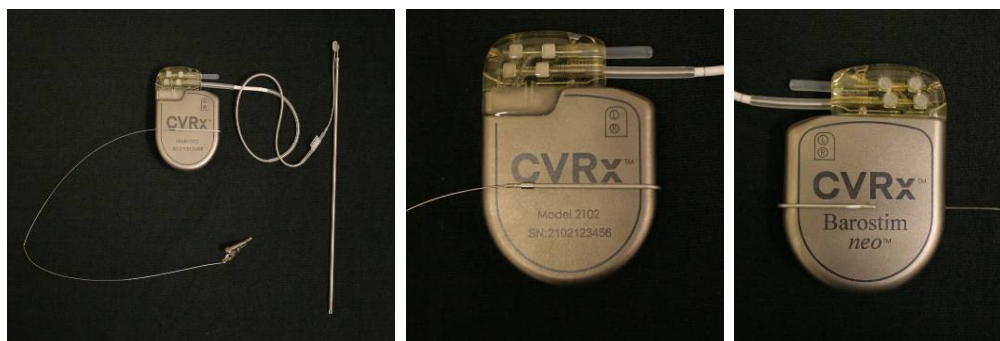

Figure 14: Implant Adapter Configuration and IPG Connection for Implant Adapter Model 5033

15) Directions for alternative non-adapter option.

An alternative option is to form the IPG pocket, place IPG in pocket, and use IPG as the return anode instead of needle. In this case, connect the lead directly into the IPG header and tighten the setscrews using the torque wrench. It is recommended that a port plug be placed in the unused port and the tip setscrew tightened using the torque wrench. If this option is used:

- Take extra pre-cautions to reduce risk of infection
- Coordinate with anesthesia team, as forming the IPG pocket typically requires additional anesthesia.

16) Place the Implant Tool into the buckle located on the inactive side of the electrode (refer to Figure 15). Tool can be bent to accommodate mapping process.



Figure 15: Buckle lead engaged in Buckle Implant Tool

17) Systematically map the carotid sinus for blood pressure response using lead and Implant Tool (refer to Figure 16 for strategy example) mapping areas of the carotid sinus in the following order (refer to figure for locations).

- A. Begin on the anterior aspect of exposed internal carotid artery adjacent to bifurcation (see section A, Figure 16)
- B. Move to the base of internal carotid artery on free wall (opposite external carotid) (see section B, Figure 16)
- C. Move to the common carotid artery, just below bifurcation (see section C, Figure 16)
- D. Deeper around common carotid from C, down from B, diagonal from A (see section D, Figure 16)
- E. Expose further above bifurcation (cephalad) and if no optimal location is identified consider positions on the posterior side of the carotid sinus (see section E, Figure 16)

- F. Further optimize location with best response by mapping small subsections around this location

Note: During mapping, maintain full contact of the electrode and backer against the carotid sinus with gentle pressure (minimize vessel deformation with the electrode).

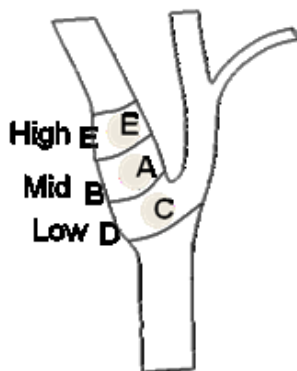

Figure 16: Systematic Mapping Strategy for Different Locations on the Exposed Carotid Sinus.

Push the **Edit and Test** button for one of the Therapies.

Note: Mapping to find the proper location of the electrode requires an assessment of the baroreflex response to stimulation. The most consistent response during implantation is derived from measures of heart rate and blood pressure, derived either from intra-arterial line or finger cuff plethysmography. Systemic vascular resistance may also be used, however this may not be available at all centers. In all cases, one would expect a change in at least one of these parameters as a guide to implantation of the electrode.

Stimulation process for mapping should be as follows:

- a. Uncheck both Pathways. Press **Test Now** and use the Elapsed Time to wait for the desired amount of time before measuring the baseline hemodynamic and/or physiological parameters.
- b. Initiate response testing.
- c. Check the box of the desired Pathway and set an amplitude of 6 mA and a pulse width of 125 μ s and a frequency of 80pps. To initiate therapy, press the **Test Now** button. Lower currents may be tried first to assess patient sensitivity to the therapy. Amplitudes from 5 to 10 mA may be required with higher pulse widths. During carotid sinus mapping, the duration of each test activation should be sufficient to determine the hemodynamic response, which can typically be determined within 30 to 60 seconds but may take 120 seconds or more.
- d. It is recommended that lower settings be used (Including Off) if:
 - Concerning changes in hemodynamics occur or
 - Problematic tissue stimulation is noted or
 - Monitoring of any other implanted electrical device indicates undesirable interaction (see “Device Interaction Testing” in Section 9) or
 - Any other potentially hazardous patient responses are observed
- e. Measure and record the hemodynamic and/or physiological response.

- f. Press the **Stop Test** button to discontinue therapy.
- 18) When the optimal location is identified, suture the electrode to the adventitia of the carotid sinus, keeping in mind the following considerations:
- It may be helpful to mark optimal location with tissue pen.
 - The goal is to ensure the electrode is securely fixed, with good contact between
 - Electrode and artery.
 - Backer and artery.
 - It is recommended that six 5-0 or 6-0 non-absorbable, monofilament sutures (e.g. Prolene) be placed. Refer to Figure 17 for approximate locations.
 - The Implant Tool may be used to stabilize the lead for suturing (especially the first suture).
 - The sutures (especially the first suture) may require a parachuting technique to enable placement through the small incision.
 - Sutures should incorporate the adventitia and the electrode backer (Refer to Figure 18).
 - After securing the electrode with some (e.g. two or three) sutures, the adequacy of the position can be confirmed by briefly applying a test current to the electrode.
 - After confirming the proper position, the buckle on the inactive side of the electrode should be removed, or at least cut, to better facilitate electrode suturing and electrode conformance to artery.
 - Complete electrode fixation with the final two or three sutures.

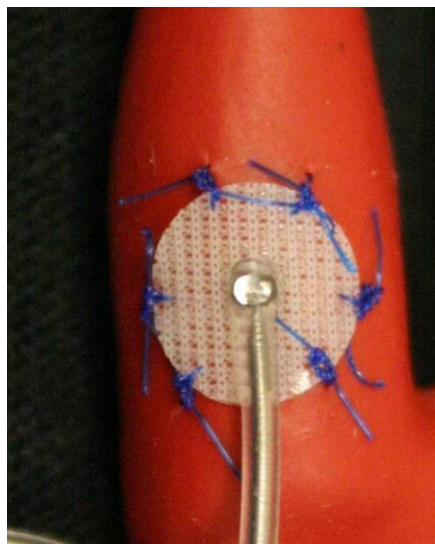
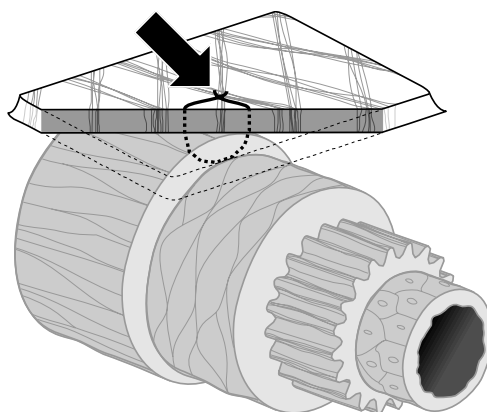

Figure 17: Recommended Suture Locations



ID# T00117A

Figure 18: Depth of Suture

- Orientation of the lead body following electrode suturing is not critical as long as creation of a strain relief loop is achievable. If possible, the preferred orientation of the lead body is parallel to the artery. Final orientation should consider the particular patient anatomy and the final electrode position (subsequent figures depict lead body orientation in inferior direction).

Final Lead Position Verification

- 19) After completing suture fixation, perform final stimulation test to verify correct positioning.
 - a. Record baseline hemodynamic and/or physiological measurement.
 - b. Initiate response testing.
 - c. Initiate CSL activation (typically at 2 mA and 65 μ s) by checking the box of the desired Pathway and pressing **Test Now**.
 - d. It is recommended that lower settings be used (Including Off) if:
 - Concerning changes in hemodynamics occur or
 - Problematic tissue stimulation is noted or
 - Monitoring of any other implanted electrical device indicates undesirable interaction (see “Device Interaction Testing” in Section 9) or
 - Any other potentially hazardous patient responses are observed
 - e. Wait approximately 1 minute.
 - f. Record hemodynamic and/or physiological response.
 - g. Increase the current in 1-2 mA increments and follow the directions in steps e and f.
 - h. Stop testing at a maximum of 12 mA or when one of the stopping points listed in step d is reached or when an adequate hemodynamic and/or physiological response has been demonstrated.
 - i. Press **Stop Test** to discontinue therapy.
 - j. The temporary anode needle may be removed at this point

NOTE: After completing the mapping and lead suturing phase of the procedure, the anesthetic regimen may be changed to include propofol or other agents preferred by the attending anesthesiologist irrespective of their potential blunting effects.

Strain Relief, Tunneling and Pocket Creation

- 20) Place strain relief loop into the lead body between the electrode and suture tab (refer to Figure 19 for example).
 - Ensure that the strain relief loop is approximately 1 inch (2 -3 cm) in diameter.
 - The suture tab should be sutured to the adventitial layer of the common carotid artery or external carotid (inferior or medial/lateral location as driven by patient anatomy). The location of loop may vary based upon this suture tab location.

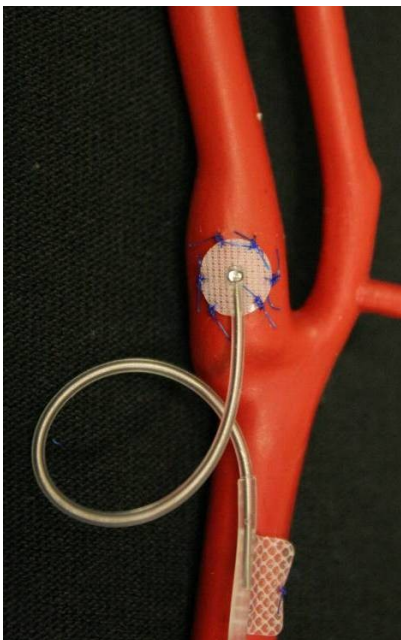

Figure 19: Strain Relief Example

- 21) A tunnel should be initiated on the superficial aspect of the common carotid artery, deep to the sternocleidomastoid muscle, extending from the cervical incision caudally towards the space between the sternal and clavicular heads of the sternocleidomastoid. Alternatively, this may be performed before formation of the strain relief loop described in step 20). Irrespective of whether this step is performed before or after fashioning the strain relief loops, care must be taken to avoid traction on the electrode or lead body during this step.
- 22) If not already completed in step 13), the skin is incised for the IPG pocket, in the infraclavicular location, and the dissection carried down to the level of the pectoralis major fascia.
 - Fashion the pocket in the subcutaneous or subfascial plane depending upon personal choice and patient anatomy.
 - The pocket should be placed on the same side as the lead/electrode implant, unless precluded by the patient's anatomy or prior device implantation.
 - Care should be taken regarding the pocket creation to assure that the lead body does not contact the IPG in the pocket. This is accomplished by developing an additional subcutaneous space at the cephalad most aspect of the IPG pocket to allow redundant lead body to be coiled without tension and away from the main IPG.
 - The orientation of the IPG requires attention because the setscrews are accessed on the side of the IPG with the Neo label and the port label (the other side has the device model and serial numbers).

- IPG located on patient's right side

If the *neo* label is faced outward (i.e. toward the surgeon) when the pocket is placed on the right side of the chest wall, the lead exits to the patient's right of the IPG, which will require a lateral extension to the IPG pocket for the redundant lead placement. To avoid a lateral extension when the pocket is on the right side of the chest, the device may be implanted with the *neo* label facing inward (i.e. toward the thoracic cavity) so that the pocket extension is medial to the IPG pocket.
 - IPG located on patient's left side

If the Neo label is faced outward when the pocket is placed on the left side of the chest, the extension is medial to the IPG pocket.
- 23) Complete the cervical tunnel initiated in step 21) deep to the sternocleidomastoid muscle from the cervical incision to the level of the space between the sternal and clavicular heads of the SCM.
 - 24) Pass a clamp from the lateral aspect of the IPG pocket in the subcutaneous plane between the heads of the SCM, until the clamp comes in contact with a finger introduced into the cervical tunnel. When the tunnel is completed, advance a catheter (e.g. 14 Fr Red Robinson) into the tunnel from the cervical pocket caudally.
 - 25) Grasp the 14 Fr Red Robinson catheter (or similar device) with the clamp and bring this through the tunnel.
 - 26) Bring the lead body through the tunnel by inserting the connector into the Red Robinson catheter.
 - Avoid tension or traction to the electrode or suture tab during the tunneling procedure.

NOTE: While handling the CSL, do not grasp the lead body or active area of the electrode with metal clamps or forceps.

Lead Connection and Wound Closure

- 27) Connect the CSL to the IPG

NOTE: Left lead connects to top header port and Right lead connects to bottom header port of the IPG.

- Remove Implant Adapter from the IPG header port, if applicable.
- Expose the lead terminal. Clean any blood or tissue from the lead terminal and inspect lead for any damage prior to attaching it into the IPG.
- Insert terminal into appropriate header port. It may be helpful to place the torque wrench into the seal plug prior to inserting the terminal.
- Visually verify that the terminal is fully inserted into header by viewing seals visible between setscrew blocks (refer to Figure 20 and Figure 21).
- For the port with a lead inserted, use a torque wrench to tighten each setscrew in clockwise direction until torque wrench begins clicking. The IPG contains 2 setscrews for each lead port; when connecting a therapy lead ensure both are tightened.
- Verify proper connection using a slight tug on the lead terminal and an impedance check.

NOTE: Electrical connection to the IPG is not established until the setscrew(s) are completely tightened using the torque wrench. Do not attempt to deliver any therapy until the connections are secured using the torque wrench.

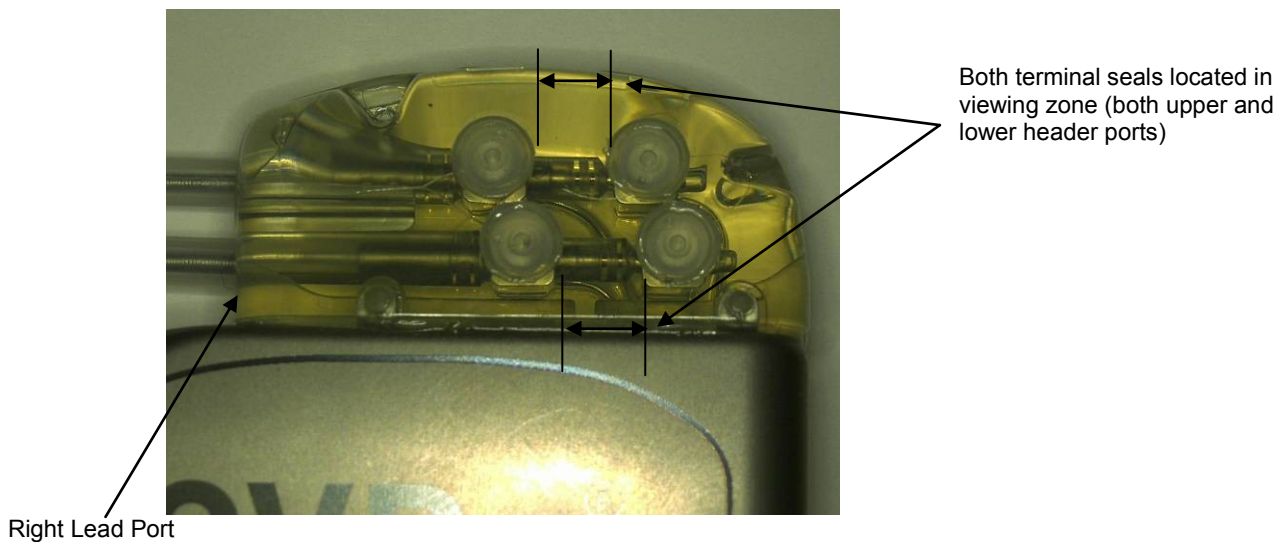

Figure 20: Terminal Insertion into IPG Header (Correct Insertion)

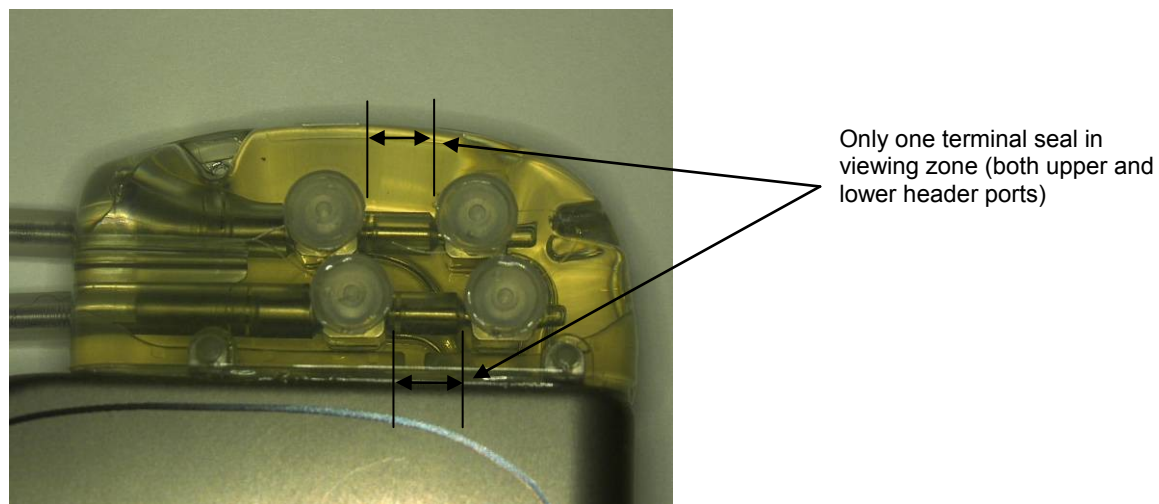

Figure 21: Terminal Insertion into IPG Header (Incorrect Insertion)

- 28) It is recommended that a port plug be placed into the unused lead port on the header. The tip setscrew should be tightened when using the port plug.
- 29) If the pocket is in the subcutaneous location place two sutures into the fascia, spaced appropriately for the suture holes in the IPG. This should be a nonabsorbable suture 0 or 1-0 (Ethibond, Silk or Prolene).
- 30) Place the sutures through the suture holes in the IPG header.
- 31) Insert the IPG into the pocket.

- 32) Gently coil excess lead body and place adjacent to the IPG (Figure 22) such that the excess lead body is not placed directly in front or behind the IPG (Figure 23). Ensure that lead body is not pulled taut and allow slack in the path between electrode and IPG pocket.

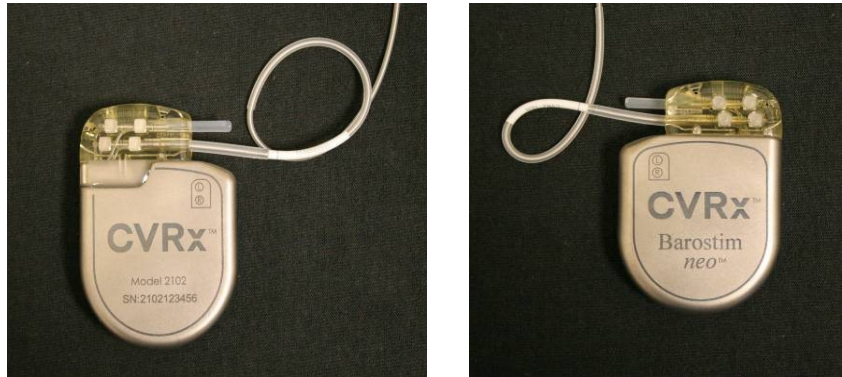
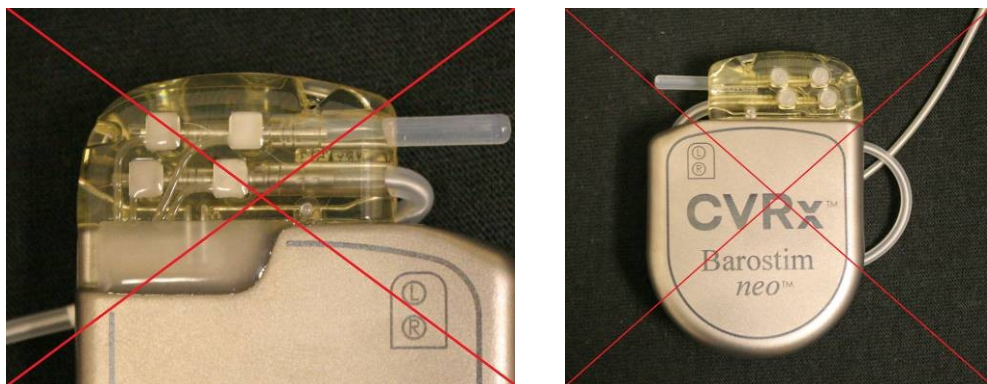

Figure 22: Correct Placement of Excess Lead Body



Incorrect severe lead angle from header

Incorrect placement of lead behind IPG

Figure 23: Incorrect Placement of Excess Lead Body

- 33) Tie the suture used to secure the IPG to the fascia.
- 34) If a subfascial pocket is used, close the fascia over the IPG.
- 35) Irrigate the pocket with an antibiotic solution.
- 36) Check the impedance of the system to assure the adequacy of the electrical connections. Note that the IPG needs to be in the pocket for an accurate impedance measurement.
- 37) Consider infiltrating the incisions with local anesthetic
- 38) Close the incisions per the surgeon's usual practice.
- 39) Document the initial in situ configuration via radiograph.

Pre Discharge Device Testing

1. The patient should be seated or in a hospital bed at an angle of approximately 45°-90°. The patient should sit with back and arms supported for at least 5 minutes before hemodynamic and/or physiological measurements are taken. Push the **Edit and Test** button for one of the Therapies.
2. Measure baseline hemodynamic and/or physiological values.
3. Initiate CSL activation (typically at 2 mA and 65 µs) by checking the box of the desired Pathway and pressing **Test Now**.
4. It is recommended that the IPG be programmed to lower settings (Including Off) if:
 - Concerning changes in hemodynamics occur or
 - Problematic tissue stimulation is noted or
 - Monitoring of any other implanted electrical device indicates undesirable interaction (see “Device Interaction Testing” in Section 9) or
 - Any other potentially hazardous patient responses are observed
5. Wait approximately 1 minute
6. Record the patient’s hemodynamic and/or physiological response.
7. Repeat steps 2 through 6 at increasing pulse amplitude to optimize settings.
8. Other parameters including, but not limited to, pulse width, frequency, and pathway (if applicable) can be tested independently using a similar process if desired.

Additional Lead Implant (if required)

If an additional lead is required at a later date, the implant procedure is similar to the steps outlined in this section. However, there are a few additional instructions required for lead placement:

- Follow steps for removing IPG as outlined in section 11, steps 1 through 6.
 - Remove port plug
 - The IPG does not need to be replaced if acceptable battery life is remaining
- New lead should be tunneled along new path, avoiding tunneling interaction or contact with lead previously implanted.
- Insert lead connectors into respective ports on IPG and follow remaining steps as previously described for completing implant, Lead Connection and Wound Closure, section 10.

11. IPG REPLACEMENT PROCEDURE

Recommendations

An IPG replacement procedure should be performed on or before the Recommended Replacement Time.

The surgical approach and techniques for the replacement of the IPG will vary with the preference of the surgeon performing the procedure. Although the approach and the techniques may vary, essential requirements for proper and safe replacement of the IPG are included in this section.

Local anesthetics are typically used during this replacement procedure.

Antibiotic Coverage

It is recommended that an antibiotic providing gram-positive coverage be administered within 30 minutes of the skin incision and continued postoperatively for 24 hours following the procedure.

Explantation of Depleted IPG

CAUTION: Palpate the site of the IPG and lead prior to first incision to verify the lead is not under the targeted incision site for IPG removal.

NOTE: During the explantation procedure, take care to avoid damage to the implanted leads. Electrocautery at a low but effective power can be used to minimize the potential of damaging the leads during dissection. Do not use scalpels on or near the CSL as damage could occur leading to failure of the lead.

1. Initiate a telemetry session with the IPG and press the **Stop** button. **Save Report** (if desired) and **End Session**.
2. Open the incision inferior to the clavicle over the implanted IPG.
3. Using electrocautery or blunt dissection, dissect down to the IPG. Portions of the lead(s) may need to be dissected in order to remove the IPG.
4. Cut the fixation sutures. Prior to removing the IPG, it is recommended to disconnect the lead(s) from the connector ports (refer to steps 5 and 6). Remove the IPG from the pocket.
5. Using the torque wrench, turn the setscrews counterclockwise to loosen the setscrews for each CSL connector.
6. Remove the CSL(s) from the IPG connector ports, ensuring that the left and right leads (if applicable) can be properly identified during reconnection.
7. Remove the IPG from the sterile field.
8. Return the explanted IPG to CVRx for examination and proper disposal.

NOTE: Prior to returning the IPG, obtain a CVRx Returned Goods Authorization kit and follow the procedure contained within it.

Implantation of Replacement IPG

NOTE: Verify replacement IPG is compatible with the lead system currently implanted in the patient. The IPG Model 2102 is compatible with Lead models 103x and can be used to replace IPG model 2101.

IPG implantation should be performed using the steps contained in the Implant Procedure Section, Lead Connection and Wound Closure, section 10.

12. EXPLANTATION PROCEDURE

Recommendations

Lead explantation should be considered with caution if, in the opinion of the treating physician, it is medically necessary.

The surgical approach and techniques for the explantation of the system will vary with the preference of the explanting surgeon. Although the approach and the techniques may vary, essential requirements for proper and safe explantation of the system are included in this section. Should the IPG require explantation, the electrode(s) (one or both sides if applicable) may or may not have to be removed at the same time depending on the clinical situation.

Antibiotic Coverage – Not Infected

If the device is being removed for reasons other than infection, it is recommended that an antibiotic providing gram-positive coverage be administered within 30 minutes of the skin incision and continued postoperatively for 24 hours following the procedure.

Antibiotic Coverage – Infected

If the device is being removed due to an infection and cultures have identified the responsible bacteria, antibiotics that would be effective against identified bacteria should be initiated preoperatively and continued postoperatively until signs of infection have resolved (normal temperature, white blood cell count, and differential white blood cell count). Otherwise it is recommended that broad spectrum antibiotics be initiated preoperatively and antibiotics be narrowed when culture and sensitivity results are available from intraoperative cultures.

IPG Explantation

NOTE: Electrocautery at a low but effective power can be used to minimize the potential of damaging the leads during dissection. Do not use scalpels on or near the CSL as damage could occur leading to failure of the lead.

1. Initiate a telemetry session with the IPG and press the **Stop** button. **Save Report** (if desired) and **End Session**.
2. Open the incision inferior to the clavicle over the implanted IPG.
3. Dissect down to the IPG. Portions of the leads may need to be dissected in order to remove the IPG.
4. Cut the fixation sutures. Prior to removing the IPG, it is recommended to disconnect the leads from the connector ports (refer to steps 5 and 6). Remove the IPG from the pocket.
5. Using the torque wrench, turn the setscrews counterclockwise to loosen the setscrews for each CSL connector.
6. Remove the CSLs from the IPG connector ports.
7. Remove the IPG from the sterile field.
8. Return the explanted IPG to CVRx for examination and proper disposal.

NOTE: Prior to returning the IPG, obtain a CVRx Returned Goods Authorization kit and follow the procedure contained within it.

CSL Explantation

1. Initiate a telemetry session with the IPG and press the **Stop** button. **Save Report** (if desired) and **End Session**.
2. In preparation for explantation of the lead body(s) and carotid sinus electrode(s), review the implantation records such as the operative report. These documents may provide insight as to the relevant regional anatomy structures with which the electrode is in contact, e.g., anatomic relationship to the bifurcation; superior thyroid vessels; and hypoglossal and vagus nerves, and how much of the electrode is in-situ, assuring complete explantation of the lead.
3. For a lead to be explanted, make an incision over the corresponding carotid bifurcation.
4. Dissect to fully uncover the CSL body in the caudal portion of the cervical incision. Free up the lead body extending cranially until reaching the caudal-most extent of the electrode. Reference should be made to the implantation work sheets for a review of regional structures in contact with the electrode. The vagus nerve is identified and protected during this and subsequent dissections.
5. Dissect to the points where the electrode is sutured to the carotid sinus adventitia.
6. Cut the sutures used to attach the electrode and suture wing.

NOTE: It is recommended that the sutures be cut on the surface of the electrode to avoid injury to the surrounding tissue.

7. Apply gentle traction to the lead body and open the enveloping scar tissue in a caudal-to-cranial direction. This is continued until the caudal border of the carotid sinus electrode is encountered. Taking care to avoid injury to the hypoglossal nerve, open the sleeve of enveloping scar tissue and cut the sutures holding the electrode backer to the carotid adventitia. Apply gentle traction to remove the electrode from the carotid sinus.

NOTE: If the electrode will not slide out of the enveloping fibrous tissue, further mobilization is required.

8. Using the torque wrench, turn the setscrews counterclockwise to loosen them.
9. Disconnect the CSL from the IPG connector ports.
10. Advance a small clamp along the CSL body to open the sheath of scar tissue enveloping the lead body.
11. From the cervical incision, apply gentle traction to remove the CSL.

NOTE: If the lead cannot be extracted by this procedure, further manipulation, such as transection above the level of the IPG pocket or sequential dilation of the scar tissue sleeve, will be required.

12. Disinfect the CSL components and double seal them in a pouch or other container labeled with a biohazard warning.
13. Return the explanted CSL to CVRx for examination and proper disposal.
14. Follow the procedures in Section 10 for implantation of any new components.

NOTE: Prior to returning the CSL, obtain a CVRx Returned Goods Authorization kit and follow the procedure contained within it.

13. INSTRUCTIONS FOR PATIENTS

The following information should be provided to patients who are implanted with this system.

- The system is designed to supplement, not replace other therapy measures such as medications, diet, exercise, and lifestyle modification.
- Implantation of the system requires the patient to carry an identification card to provide information to security personnel at public institutions with metallic screening security systems.
- The IPG requires periodic replacement due to depletion of the unit's batteries.
- Implantation of the system requires the patient to return for regular follow-ups to check the operation of the system and response to therapy.
- Patients should contact their physician if they have any of the following symptoms.
 - They experience symptoms that may be related to the therapy. Symptoms include unusual stimulation of tissue near the lead electrode tips; slight tingling or twitching of neck muscles; difficulty in talking or swallowing.
 - They experience increased symptoms of dizziness, feeling faint, light-headedness, chest pain, increasing shortness of breath, or edema.
 - Their systolic pressure falls below 90 mmHg and/or their diastolic pressure falls below 50 mmHg.
 - Their heart rate falls below 50 BPM.

Warning: Certain medical procedures such as Magnetic Resonance Imaging (MRI), diathermy therapy including shortwave, microwave, or therapeutic ultrasound diathermy are contraindicated following the implantation of the system.

14. EMERGENCY PERSONNEL INFORMATION

Radiopaque Identifier

The IPG has a unique radiopaque identifier that allows medical personnel to use X-ray to identify information about the implanted medical device. An example of an IPG radiopaque identifier is shown in (Figure 24) along with a description of the identifying characters.



Figure 24: Radiopaque Identifier

The radiopaque identifier indicates the following.

- CVRx as the company for which the IPG was manufactured.
- The model of the IPG (example: A5 = Model 2102).
- The year in which the IPG was manufactured (example: 11=2011).

The following graphic shows the general location of the IPG (Figure 25).

NOTE: The device may be implanted on patient's right or left side. The following illustration shows the device implanted on the patient's right side.

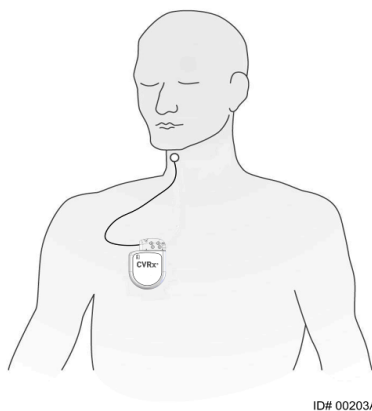

Figure 25: Implanted Location of IPG

ECG Artifact

Artifacts in ECG tracings may be seen when the IPG is active.

Temporarily Inhibiting the IPG Output

The magnet is intended to be available to a primary care physician and emergency medical services personnel. Use the CVRx Magnet to *temporarily* inhibit the IPG output when the output is active. Position the center hole of the magnet over the area of the IPG connector block and leave in place to inhibit output. Remove the magnet to resume prescribed IPG therapy.

15. TROUBLESHOOTING

CVRx Contact Information

CVRx, Inc.
 9201 West Broadway Avenue, Suite 650
 Minneapolis, MN 55445 USA
 Phone: (763) 416-2840
 Fax: (763) 416-2841
 Email: engineering@cvrx.com
www.cvr.com

Programmer System and Warning messages

This section provides a list of System and Warning messages you may encounter while attempting to use the CVRx Programmer Software Application:

As part of the troubleshooting activity save a diagnostics file. This file should be sent to CVRx for advanced trouble shooting support. To save the diagnostics file, open the CVRx Launcher application, go to the **Programmer Diagnostics** button and select **Save PGM Diagnostics**.

System/Warning Message	Possible Cause(s)	Troubleshooting
PGM005 - Programmer Not Connected PGM006 - Programmer Connection Problem PGM007 - Programmer Failure	<ul style="list-style-type: none"> Poor USB connection Damaged Programmer Interface Damaged Programmer Interface USB cable 	<ol style="list-style-type: none"> Ensure Programmer Interface USB cable is properly connected. Ensure Programmer Interface USB cable is not cut or otherwise damaged. Ensure green power indicator is lit on Programmer Interface. Disconnect, and then reconnect the USB cable. If problem persists, exit and then restart application If problem still persists, contact CVRx
IPG002 - Unable to Interrogate IPG IPG007 - Programming Request Three question marks "???" is displayed for a parameter or lead impedance measurement	<ul style="list-style-type: none"> Loss of communication. 	<ol style="list-style-type: none"> Ensure that the Programmer Interface is placed in its upright position with no obstructions between the Programmer Interface and the IPG. Ensure the Programmer Interface front or back side label is facing the IPG. Ensure the distance from the Programmer Interface and the IPG is no more than 2 meters. If problem persists , exit and then restart application If problem still persists contact CVRx

If software stops responding to keyboard or pointer device input: the user may use task manager (accessed by pressing ctrl-alt-delete) and close the application. The user can then restart the application. If that is unsuccessful, the programmer computer can be restarted to recover functionality.

16. WARRANTY / DISCLAIMER OF WARRANTY**IMPORTANT NOTICE – LIMITED WARRANTY**

This Limited Warranty is provided by CVRx, Inc. 9201 West Broadway Avenue, Suite 650, Minneapolis, MN 55445.

This LIMITED WARRANTY assures the patient who receives Neo (referred to as the “Product”) that, should the Product not function to specification for any reason other than battery depletion within one year after implant (“Warranty Period”), CVRx will provide a replacement at no charge. If the Product’s battery is depleted during the Warranty Period, CVRx will provide a replacement at a discounted cost. The discount will be based on the ratio of the time remaining in the Warranty Period on the date of depletion to the entire Warranty Period.

All Warnings contained in the Product labeling are an integral part of this LIMITED WARRANTY.

To qualify for the LIMITED WARRANTY, these conditions must be met:

The Product must be used prior to its “Use By”  date.

The Product must not have been repaired or altered outside of CVRx’s control in any way which, in the judgment of CVRx, affects its stability and reliability. The Product must not have been subjected to misuse, abuse or accident.

The Product must be returned to CVRx within 30 days of discovery of the potential non-conformity leading to a claim under this LIMITED WARRANTY. All returned Product shall be the property of CVRx

CVRx is not responsible for any incidental or consequential damages, including but not limited to medical fees, based upon any use, defect, or failure of the Product, whether the claim is based on warranty, contract, tort, or otherwise.

This Limited Warranty is made only to the patient who receives the Product. As to all others, CVRx makes no warranty, express or implied, including but not limited to, any implied warranty of merchantability or fitness for a particular purpose, whether arising from statute, common law, custom or otherwise. No such express or implied warranty to the patient shall extend beyond the period of one (1) year. This Limited Warranty shall be the exclusive remedy available to any person.

The exclusions and limitations set out above are not intended to and should not be construed so as to contravene any mandatory provisions of applicable law. If any part or term of this LIMITED WARRANTY is held by a court of competent jurisdiction to be illegal, unenforceable, or in conflict with applicable law, the validity of the remaining portions of this LIMITED WARRANTY shall not be affected and all rights and obligations shall be construed and enforced as if this Disclaimer of Warranty did not contain the particular part or term held to be invalid.

No person has any authority to bind CVRx to any representation, condition or warranty except this Limited Warranty.

17. REGULATORY NOTICES

The transmitter in the Implantable Pulse Generator has been certified under IC: 9464A-IPG210A.

The transmitters in the Programmer Interface have been certified under IC: 9464A-PGM901.

The term “IC:” before the equipment certification number only signifies that the Industry Canada technical specifications were met.

This device may not interfere with stations operating in the 400.150-406.000 MHz band in the meteorological aids, meteorological-satellite, and earth exploration-satellite services and must accept any interference received, including interference that may cause undesired operation.

Operation is subject to the following two conditions: (1) this device may not cause interference, and (2) this device must accept any interference, including interference that may cause undesired operation of the device.

18. SPECIFICATIONS OF NONIMPLANTABLE COMPONENTS

Programmer System

Specification	Value
Operating temperature	50° F to 95° F (10° C to 35° C) If equipment has been stored at temperature extremes, then the equipment should be placed at operating temperature for at least 1 hour prior to use.
Atmospheric pressure	525 mmHg to 760 mmHg (700 hPa to 1010 hPa)(10.2 psia to 14.7psia)
Vibration	0.5G, 10 to 500 Hz, 0.5 octave/min sweep rate
Storage/shipping temperature	-4° F to 140° F (-20° C to 60° C)
Storage/shipping humidity	5% to 90% relative humidity

Programmer System Components

Component	Specification	Value
Programmer Interface	Power Supply Input	From computer
Programmer System IEC60601-1-2 System Clause	Additional equipment connected to medical electrical equipment must comply with the respective IEC or ISO standards (e.g., IEC 60950-1 for data processing equipment). Furthermore, all configurations shall comply with the requirements for medical electrical systems (see IEC 60601-1-1 or clause 16 of the 3 rd Ed. Of IEC 60601-1, respectively). Anybody connecting additional equipment to medical electrical equipment configures a medical system and is therefore responsible that the system complies with the requirements for medical electrical systems. Attention is drawn to the fact that local laws take priority over the above-mentioned requirements. If in doubt, consult your local representative or the technical service department.	
Programmer Interface IEC60601-1-1 System Clause	The Programmer Interface is suitable for use in the patient environment.	

Computer

Specification	Value
Safety and EMC Requirements	<ul style="list-style-type: none"> • EN 60950-1 • UL 60950-1 • EN 55022 • EN 55024 • FCC Part 15 Class B emissions



Miscellaneous Information

Description	Information
Type of protection against electric shock	The Programmer Interface is not mains powered equipment.
Degree of protection against electric shock	The Programmer Interface meets IEC 60601-1-1 touch current requirements.
Degree of protection against the ingress of water	Ordinary
Methods of sterilization or disinfecting	Cannot be sterilized.
Information regarding electromagnetic or other interference and advice regarding avoidance as necessary.	Do not use in the proximity of equipment that generates electromagnetic interference (EMI). EMI may cause a disruption in programmer function. Examples are cell phones, x-ray equipment, and other monitoring equipment.
Accessories or materials used with equipment that may affect safety.	Programmer Interface cable.
Cleaning and maintenance, with frequency	Refer to section on Cleaning the Programmer System if system appears dirty or soiled. No preventative maintenance is required. Do not use programmer system if programming unit or cables appear damaged. There are no serviceable items. Please contact CVRx representative to return product for service or replacement.
Equipment Supply Disconnect	Unplug power cord to isolate equipment from supply mains.
Manufacturer Name	CVRx, Inc.
Model #s	Programmer System: Model 9010 Implant Adapters: Model 5030 and 5033 Implant Tool: Model 5031 Accessory Kit: Model 5500 Magnet: Model 5000
Disposal of Product	Please contact CVRx representative to return product to CVRx. Product should not be disposed of in trash.



19. SPECIFICATIONS OF IMPLANTABLE COMPONENTS

Pulse Generator

Specification	Value
Connectors	No sensing Unipolar Stimulation (bipolar connections used with implant adapter) 1.5 mm lead pin bore diameter 3.48 mm lead shaft bore diameter
Mass	60 grams
Height	72 mm
Width	50 mm
Thickness	14 mm
Volume	< 40 CC
Materials	Titanium Can Tecothane Header Silicone Seals Stainless Steel Setscrews
Leads	Use only CVRx lead Models 103x
Materials in Accessory Kit	Port plug is comprised of a Stainless Steel shaft and silicone body
Battery	1 carbon monofluoride and silver vanadium oxide cell 7.50 Ah Theoretical Capacity
Current Consumption and Nominal Projected Life	Current Consumption depends on parameter settings. See Section 9 for details.
Disposal of Product	Please contact CVRx representative to return product to CVRx. Product should not be disposed of in trash.

Pulse Generator Parameters

Parameter	Units	Programmable Values
Therapy Schedule From/To Times for Therapy (N) or Therapy Off	HH:MM	Up to 3 entries allowed Any time during the day In 15 minute steps
Output Pathway for Therapy (N)	NA	LEFT and RIGHT are independently selectable
LEFT Pulse Amplitude for Therapy (N)	milliamp	0.8 to 20.0
RIGHT Pulse Amplitude for Therapy (N)	milliamp	0.8 to 20.0
LEFT Pulse Width for Therapy (N)	μs	15 to 500
RIGHT Pulse Width for Therapy (N)	μs	15 to 500
Therapy Frequency for Therapy (N)	PPS	10 to 100

Lead (Models 1036 and 1037)

Specification	Value (Nominal)
Length	Model 1036: 40 cm Model 1037: 50 cm
Compatibility	Compatible with CVRx Neo
Connector	
Connector Type	Compatible with CVRx Neo IPG
Pin	Active: Diameter = 1.41 mm, Active Length = 5.18 mm
Ring	Inactive: Diameter = 2.67 mm, Active Length = 4.06 mm
Connector (Pin to Ring) Length	14.22 mm (including inactive ring length)
Pin/Ring Material	Stainless Steel
Seal/ Insulating Material	Silicone Rubber
Lead Body	
Conductor Material	Cobalt-Nickel-Chromium-Molybdenum Alloy with Silver Core
Lead Body Insulation Material	Silicone Rubber
Electrodes	
Electrode Material	Platinum Iridium with Iridium Oxide Coating
Electrode Backer Material	Silicone Rubber
Disposal of Product	Please contact CVRx representative to return product to CVRx. Product should not be disposed of in trash.

20. ELECTROMAGNETIC COMPATIBILITY DECLARATIONS

Programmer System EMC Precautions

The Model 9010 Programmer System needs special precautions regarding Electromagnetic Compatibility (EMC) and needs to be installed and put into service according to the EMC information provided in this guide.

Portable and mobile RF communications equipment can affect the Model 9010 Programmer System.

The use of power cords or USB cables other than those supplied with the Model 9010 Programmer System may result in increased emissions or decreased immunity.

The Model 9010 Programmer System should not be used adjacent to or stacked with other equipment. If such use is required, then the Model 9010 Programmer System should be observed to verify normal operation in this configuration.

Programmer System RF Specifications

The Model 9010 Programmer System may be interfered with by other equipment, even if that other equipment complies with CISPR emission requirements. The RF telemetry operating specifications are:

MICS band 402-405 MHz. The effective radiated power is below the limits specified in:

- Europe: EN ETSI 301 839-2
- USA: 47 CFR 95 Subpart I
- Canada: RSS-243

2.4 GHz band 2.4-2.4835 GHz. The effective radiated power is below the limits specified in:

- Europe: EN ETSI 301 328
- USA: 47 CFR 15.249
- Canada: RSS-210

Table 3: Electromagnetic Emissions

Guidance and manufacturer’s declaration – electromagnetic emissions		
The Model 9010 Programmer System is intended for use in the electromagnetic environment specified below. The customer or the user of the Model 9010 Programmer System should assure that it is used in such an environment.		
Emissions Test	Compliance	Electromagnetic environment – guidance
RF emissions CISPR 11	Group 2	The Model 9010 Programmer System is suitable for use in all establishments, including domestic establishments and those directly connected to the public low-voltage power supply network that supplies buildings used for domestic purposes.
RF emissions CISPR 11	Class B	
Harmonic emissions IEC 61000-3-2	Class A	
Voltage fluctuations / flicker emissions IEC 61000-3-3	Complies	

Table 4: Electromagnetic Immunity

Guidance and manufacturer’s declaration – electromagnetic immunity			
The Model 9010 Programmer System is intended for use in the electromagnetic environment specified below. The customer or the user of the Model 9010 Programmer System should assure that it is used in such an environment.			
Immunity Test	IEC 60601 test level	Compliance level	Electromagnetic environment – guidance
Electrostatic discharge (ESD)	± 6 kV contact	± 6 kV contact	Floors should be wood, concrete or ceramic tile. If floors are covered with synthetic material, the relative humidity should be at least 30 %.
IEC 61000-4-2	± 8 kV air	± 8 kV air	
Electrical fast transient/burst	± 2 kV for power supply lines	± 2 kV for power supply lines	Mains power quality should be that of a typical commercial or hospital environment.
IEC 61000-4-4	± 1 kV for input/output lines	± 1 kV for input/output lines	
Surge	± 1 kV line(s) to line(s)	± 1 kV differential mode	Mains power quality should be that of a typical commercial or hospital environment.
IEC 61000-4-5	± 2 kV line(s) to earth	± 2 kV common mode	
Voltage dips, short interruptions and voltage variations on power supply input lines	<5 % U_T (>95 % dip in U_T for 0,5 cycle) 40 % U_T (60 % dip in U_T for 5 cycles) 70 % U_T (30 % dip in U_T for 25 cycles)	<5 % U_T (>95 % dip in U_T for 0,5 cycle) 40 % U_T (60 % dip in U_T for 5 cycles) 70 % U_T (30 % dip in U_T for 25 cycles)	Mains power quality should be that of a typical commercial or hospital environment. If the user of the Model 9010 Programmer System requires continued operation during power mains interruptions, it is recommended that the Model 9010 Programmer System be powered from an uninterruptible power supply or a battery.
IEC 61000-4-11	<5 % U_T (>95 % dip in U_T for 5 s)	<5 % U_T (>95 % dip in U_T for 5 s)	
Power frequency (50/60 Hz) magnetic field	3 A/m	3 A/m	Power frequency magnetic fields should be at levels characteristic of a typical location in a typical commercial or hospital environment.
IEC 61000-4-8			
NOTE U_T is the a.c. mains voltage prior to application of the test level.			

Guidance and manufacturer's declaration – electromagnetic immunity			
The Model 9010 Programmer System is intended for use in the electromagnetic environment specified below. The customer or the user of the Model 9010 Programmer System should assure that it is used in such an environment.			
Immunity Test	IEC 60601 test level	Compliance level	Electromagnetic environment – guidance
Conducted RF IEC 61000-4-6	3 Vrms 150 kHz to 80 MHz	3 V	<p>Portable and mobile RF communications equipment should be used no closer to any part of the Model 9010 Programmer System, including cables, than the recommended separation distance calculated from the equation applicable to the frequency of the transmitter.</p> <p>Recommended separation distance</p> $d = \left[\frac{3,5}{3} \right] \sqrt{P}$
Radiated RF IEC 61000-4-3	3 V/m 80 MHz to 2,5 GHz	3 V/m	$d = \left[\frac{3,5}{3} \right] \sqrt{P} \quad 80 \text{ MHz to } 800 \text{ MHz}$ $d = \left[\frac{7}{3} \right] \sqrt{P} \quad 800 \text{ MHz to } 2,5 \text{ GHz}$ <p>where P is the maximum output power rating of the transmitter in watts (W) according to the transmitter manufacturer and d is the recommended separation distance in metres (m).</p> <p>Field strengths from fixed RF transmitters, as determined by an electromagnetic site survey,^a should be less than the compliance level in each frequency range.^b</p> <p>Interference may occur in the vicinity of equipment marked with the following symbol:</p> 
NOTE 1 At 80 MHz and 800 MHz, the higher frequency range applies.			
NOTE 2 These guidelines may not apply in all situations. Electromagnetic propagation is affected by absorption and reflection from structures, objects and people.			

- a Field strengths from fixed transmitters, such as base stations for radio (cellular/cordless) telephones and land mobile radios, amateur radio, AM and FM radio broadcast and TV broadcast cannot be predicted theoretically with accuracy. To assess the electromagnetic environment due to fixed RF transmitters, an electromagnetic site survey should be considered. If the measured field strength in the location in which the Model 9010 Programmer System is used exceeds the applicable RF compliance level above, the Model 9010 Programmer System should be observed to verify normal operation. If abnormal performance is observed, additional measures may be necessary, such as re-orienting or relocating the Model 9010 Programmer System.
- b Over the frequency range 150 kHz to 80 MHz, field strengths should be less than 3 V/m.

Table 5: Separation Distance

Recommended separation distance between portable and mobile RF communications equipment and the Model 9010 Programmer System			
The Model 9010 Programmer System is intended for use in the electromagnetic environment in which radiated RF disturbances are controlled. The customer or the user of the Model 9010 Programmer System can help prevent electromagnetic interference by maintaining a minimum distance between portable and mobile RF communications equipment (transmitters) and the Model 9010 Programmer System as recommended below, according to the maximum output power of the communications equipment.			
Rated maximum output power of transmitter W	Separation distance according to frequency of transmitter m		
	150 kHz to 80 MHz $d = \left[\frac{3,5}{3} \right] \sqrt{P}$	80 MHz to 800 MHz $d = \left[\frac{3,5}{3} \right] \sqrt{P}$	800 MHz to 2,5 GHz $d = \left[\frac{7}{3} \right] \sqrt{P}$
0,01	0,12	0,12	0,23
0,1	0,37	0,37	0,74
1	1,2	1,2	2,3
10	3,7	3,7	7,4
100	12	12	23
For transmitters rated at a maximum output power not listed above, the recommended separation distance <i>d</i> in metres (m) can be estimated using the equation applicable to the frequency of the transmitter, where <i>P</i> is the maximum output power rating of the transmitter in watts (W) according to the transmitter manufacturer.			
NOTE 1 At 80 MHz and 800 MHz, the separation distance for the higher frequency range applies.			
NOTE 2 These guidelines may not apply in all situations. Electromagnetic propagation is affected by absorption and reflection from structures, objects and people.			

21. R&TTE DECLARATION OF CONFORMITY (DOC)

Unique identification of this DoC: Section 21 of 900097-001, Neo System Reference Guide

We, CVRx, Inc., located at 9201 West Broadway Avenue, Suite 650, Minneapolis, Minnesota 55445, declare under our sole responsibility that the product:

Product Name: Barostim neo™

Trade Name:	Type or model:
Implantable Pulse Generator (IPG)	2102
CVRx Programmer System	9010

Relevant Supplementary Information: Not Applicable
(e.g. lot, batch or serial number, sources and numbers of items)

to which this declaration relates is in conformity with the essential requirements and other relevant requirements of the R&TTE Directive (1999/5/EC). The product is in conformity with the following standards and/or other normative documents:

Standard Reference	Description
EN 60601-1	Medical Electrical Equipment, Part 1 General Requirements for Safety
EN 60601-1-2	Medical Electrical Equipment, Part 1-2 General Requirements for Safety, Collateral Std: Electromagnetic Compatibility - Requirements and Tests
ETSI EN 300 328	Electromagnetic compatibility and Radio spectrum Matters (ERM); Wideband Transmission systems; Data transmission equipment operating in the 2,4 GHz ISM band and using wide band modulation techniques; Harmonized EN covering essential requirements under article 3.2 of the R&TTE Directive
ETSI EN 301 489-1	Electromagnetic compatibility and Radio spectrum Matters (ERM); Electro-Magnetic Compatibility (EMC) standard for radio equipment and services; Part 1: Common technical requirements
ETSI EN 301 489-27	Electromagnetic compatibility and Radio spectrum Matters (ERM); ElectroMagnetic Compatibility (EMC) standard for radio equipment and services; Part 27: Specific conditions for Ultra Low Power Active Medical Implants (ULP-AMI) and related peripheral devices (ULP-AMI-P)
ETSI EN 301 489-17	Electromagnetic compatibility and Radio spectrum Matters (ERM); ElectroMagnetic Compatibility (EMC) standard for radio equipment; Part 17: Specific conditions for Broadband Data Transmission Systems
ETSI EN 301 839-2	Electromagnetic compatibility and Radio spectrum Matters (ERM); Radio equipment in the frequency range 402 MHz to 405 MHz for Ultra Low Power Active Medical Implants and Accessories; Part 2: Harmonized EN covering essential requirements of article 3.2 of the R&TTE Directive

Limitation of validity (if any): None

Supplementary information:

Notified body involved:

Northwest EMC
22975 NW Evergreen Parkway, Suite 400
Hillsboro, OR 97124USA

Technical file held by:

CVRx, Inc.

Place and date of issue (of this DoC):

Minneapolis, Minnesota on 24-October-2013

Signed for the manufacturer:



(Signature of authorized person)

Name (in print):

Dean Bruhn-Ding

Title:

Vice President of Regulatory Affairs & Quality Assurance

CVRx, Rheos, *neo*, Medicine ReEnvisioned, Barostim *neo*, Barostim and Barostim Therapy are trademarks of CVRx, Inc. All other trademarks are property of their respective owners.

For a list of applicable patents, see www.cvr.com/patent-marking.

©2013 CVRx, Inc. All rights reserved.

CVRx™

Medicine ReEnvisioned™



CVRx, Inc.

9201 West Broadway Avenue, Suite 650

Minneapolis, MN 55445 USA

Phone: (763) 416-2840

Fax: (763) 416-2841

www.cvr.com

CE 2013
0050

EC REP

Emergo Europe

Molenstraat 15

2513 BH, The Hague

The Netherlands

Phone: +31 70 345 8570

Fax: +31 70 346 7299

REF 900097-001 Rev. B
24-October-2013